

# VINTER

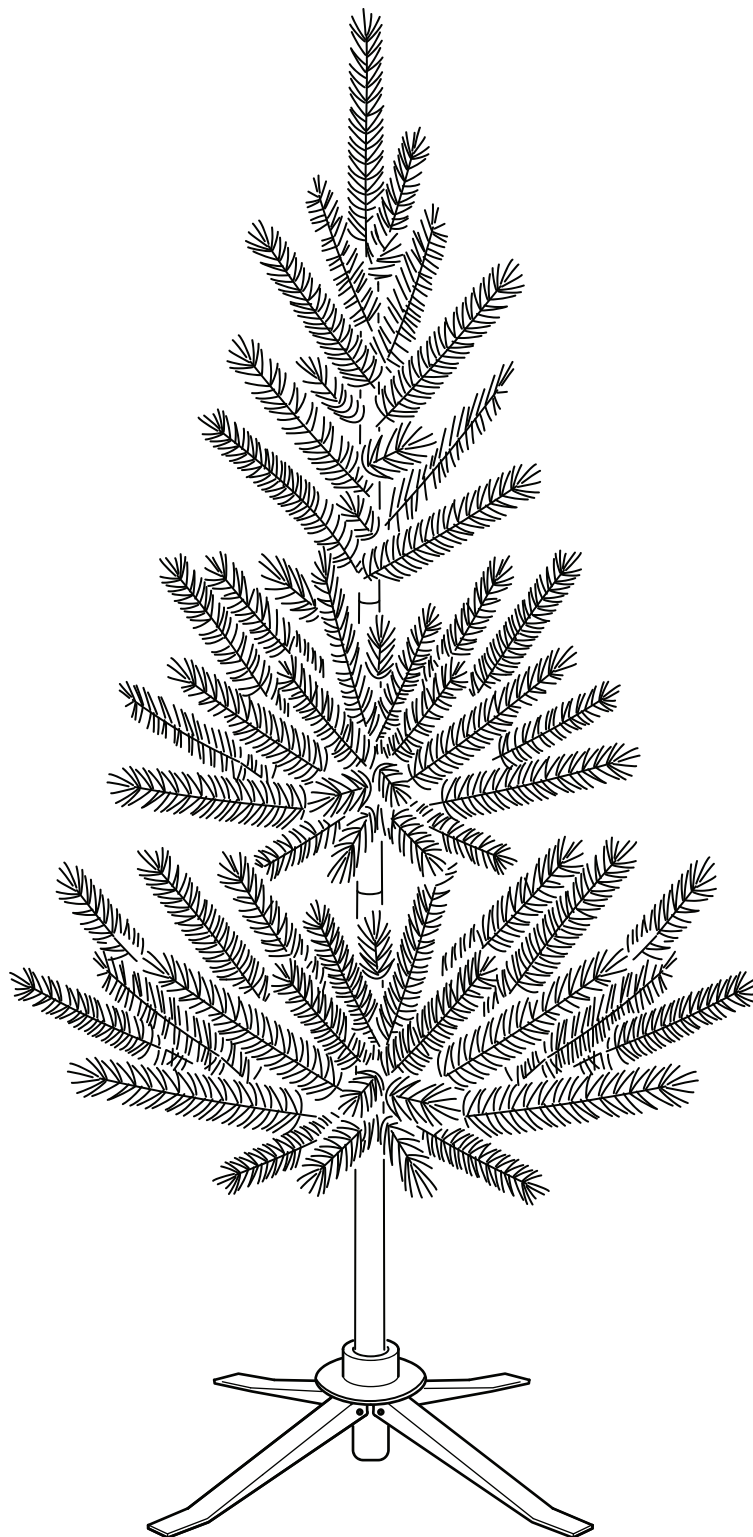

Design and Quality  
IKEA of Sweden

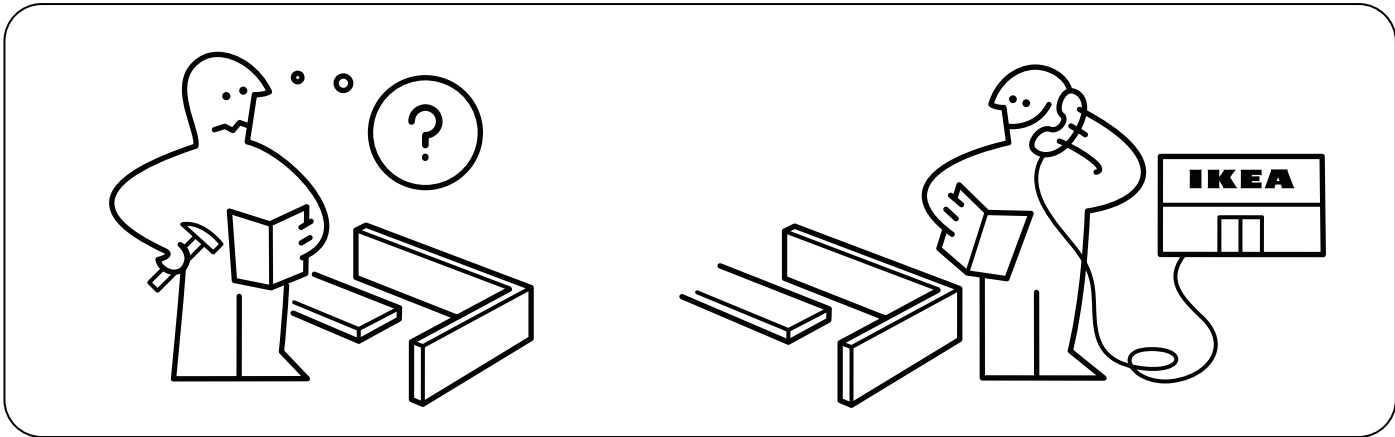

1

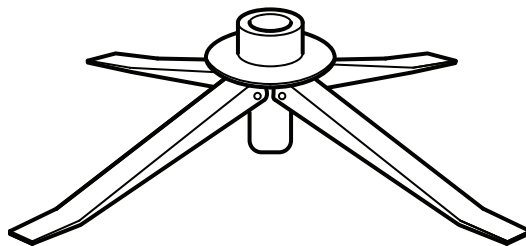
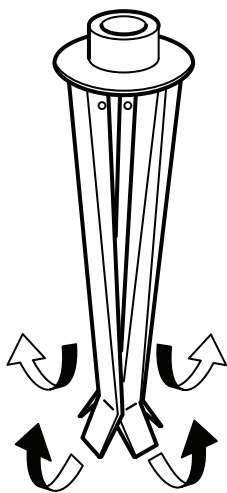

2

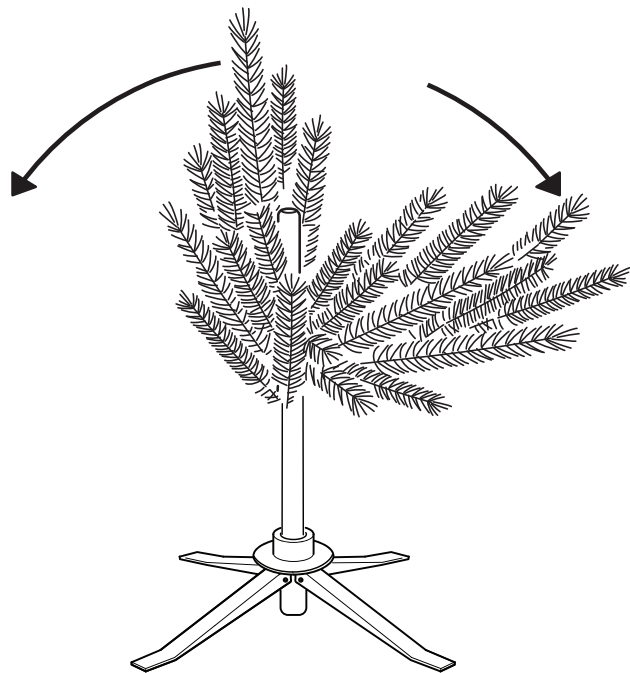
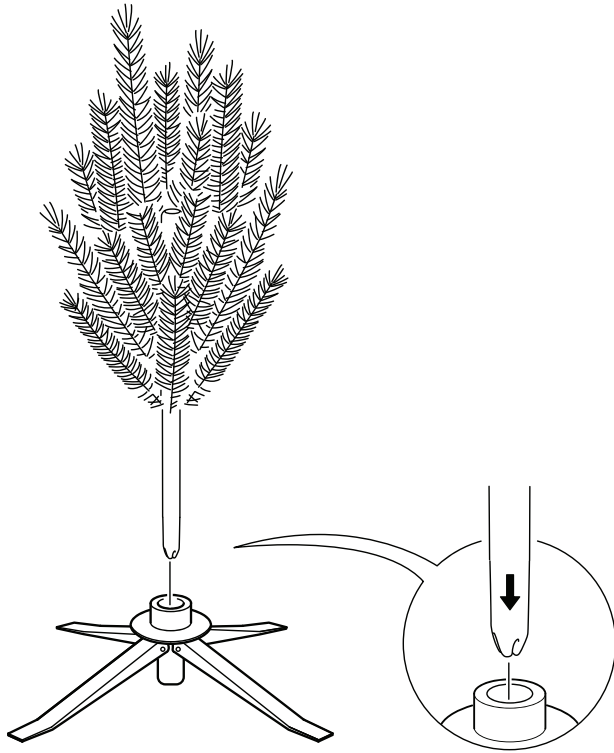

**3**

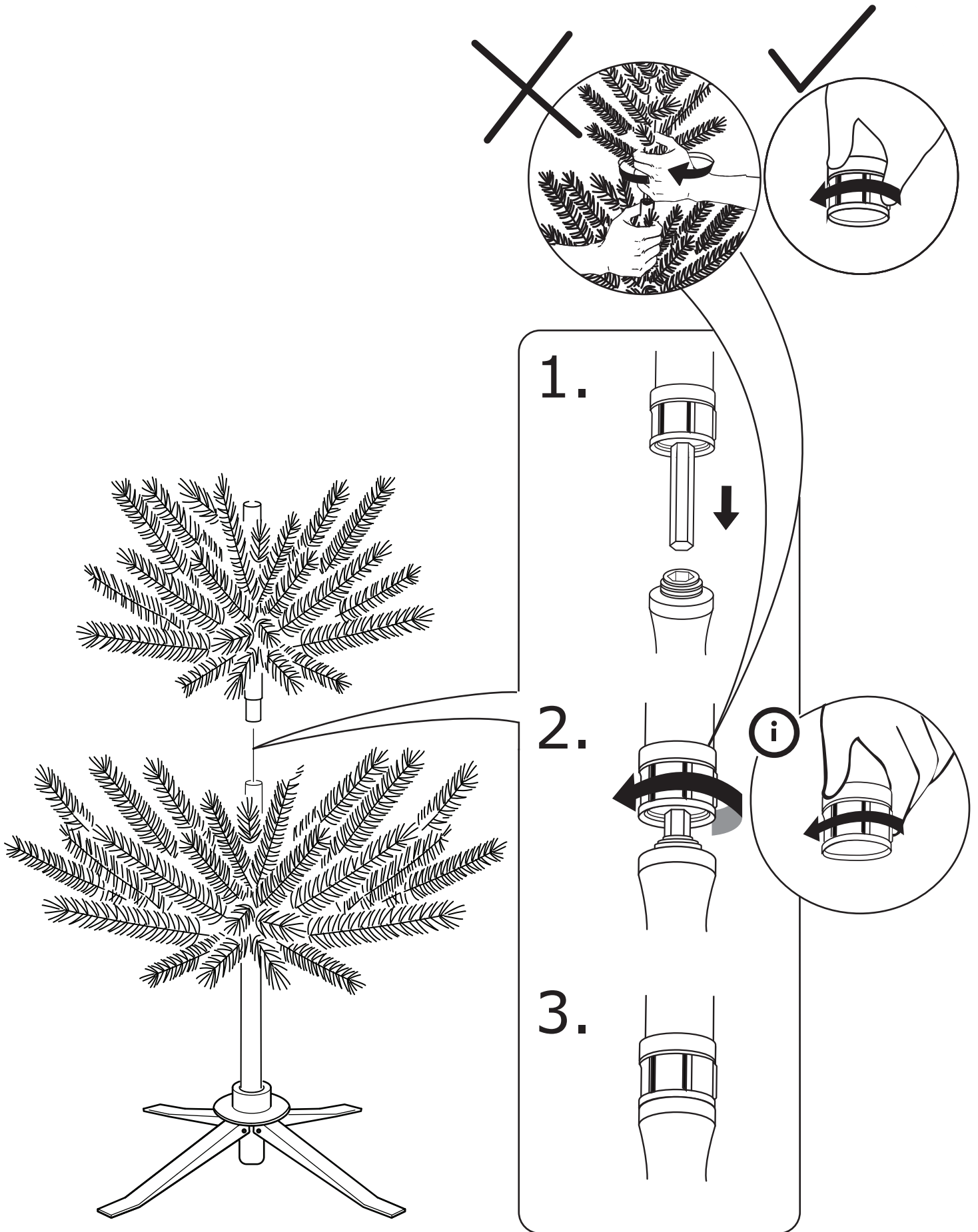

4

