

TVÄTTAD





ENGLISH

Please refer to the last page of this manual for the full list of IKEA appointed After Sales Service Provider and relative national phone numbers.

ENGLISH

4

Contents

Safety information	4	Daily use - Washing & Drying	28
Safety instructions	7	Daily use - Drying only	29
Product description	9	Fluff in the fabrics	30
Technical Data	10	Hints and tips	30
Inspection check list	11	Care and cleaning	33
First use	12	Troubleshooting	37
Control panel	12	Consumption values	41
Programmes	17	Environmental concerns	42
Settings	22	IKEA guarantee	43
Daily use	22		

Subject to change without notice.

Safety information

Before the installation and use of the appliance, carefully read the supplied instructions. The manufacturer is not responsible for any injuries or damage that are the result of incorrect installation or usage. Always keep the instructions in a safe and accessible location for future reference.

Children and vulnerable people safety



Warning!

Risk of suffocation, injury or permanent disability.

- This appliance is not intended for use by persons (including children) with reduced physical, sensory or mental capabilities, or lack of experience and knowledge, unless they have been given supervision or instruction concerning use of the appliance by a person responsible for their safety.
- Children should be supervised to ensure that they do not play with the appliance.
- Keep all packaging away from children and dispose of it appropriately.
- Keep detergents away from children.
- Keep children and pets away from the appliance when the door is open.

- If the appliance has a child safety device, it should be activated.
- Children shall not carry out cleaning and user maintenance of the appliance without supervision.

General Safety

- Do not change the specification of this appliance.
- This appliance is intended to be used in household and similar applications such as:
 - staff kitchen areas in shops, offices and other working environments;
 - by clients in hotels, motels, bed & breakfast and other residential type environments;
 - areas for communal use in blocks of flats or in laundrettes.
- Do not install the appliance behind a lockable door, a sliding door or a door with a hinge on the opposite side, that would prevent the appliance door from being fully open.
- Connect the mains plug to the mains socket only at the end of the installation process. Make sure that the mains plug is accessible after installation.
- The ventilation opening in the base must not be covered by a carpet, mat, or any floor covering.
- **WARNING:** The appliance must not be supplied through an external switching device, such as a timer, or connected to a circuit that is regularly switched on and off by a utility.
- Ensure good air ventilation in the room where the appliance is installed to avoid the backflow of unwanted gases into the room from appliances burning gas or other fuels, including open fires.
- Exhaust air must not be discharged into a flue which is used for exhausting fumes from any appliances burning gas or other fuels.

- The operating water pressure at the water entry point from the outlet connection must be between 0.5 bar (0.05 MPa) and 8 bar (0.8 MPa).
- The appliance maximum load is 8 kg. Do not exceed the maximum load of each programme (refer to the "Programmes" chapter).
- The appliance must be connected to the water mains using the new supplied hose sets, or other new hose sets supplied by the Authorised Service Centre.
- Old hose sets must not be reused.
- If the mains power supply cable is damaged, it must be replaced by the manufacturer, its Authorised Service Centre or similarly qualified persons to avoid an electrical hazard.
- Wipe away lint or packaging debris that has accumulated around the appliance.
- Items that have been soiled with substances such as vegetable or mineral oil, acetone, alcohol, petrol, kerosene, spot removers, turpentine, waxes and wax removers should be washed separately with an extra amount of detergent before being dried in the washer dryer.
- Do not use the appliance if items have been soiled with industrial chemicals.
- Do not dry unwashed items in the wash dryer.
- Items such as foam rubber (latex foam), shower caps, waterproof textiles, and rubber backed articles and clothes, or pillows fitted with foam rubber pads should not be dried in the washer dryer.
- Fabric softeners, or similar products, should only be used as specified by the product manufacturer's instructions.
- Remove all objects from items that could be a source of fire ignition such as lighters or matches.

- Never stop the washer dryer before the end of the drying cycle unless all items are quickly removed and separated so that residual heat can dissipate.
- The final part of the washer dryer cycle takes place without heat (cool down cycle) to ensure that items reach a temperature that will not cause damage to them.
- Do not use high pressure water sprays and/or steam to clean the appliance.
- Clean the appliance with a moist cloth. Use only neutral detergents. Do not use abrasive products, abrasive cleaning pads, solvents or metal objects.
- Before any maintenance operation, deactivate the appliance and disconnect the mains plug from the socket.

Safety instructions

Installation



The installation must comply with relevant national regulations.

- Follow the installation instructions supplied with the appliance.
- Do not use the appliance before installing it in the built-in structure due to safety manner.
- Do not install or use the appliance where the temperature can be less than 0°C or where it is exposed to the weather.
- Always keep the appliance vertical when it is being moved.
- Make sure that there is air circulation between the appliance and the floor.
- Remove all the packaging and the transit bolts.
- The floor area on which the appliance is to be installed must be flat, stable, heat resistant and clean.
- Keep the transit bolts in a safe place. If the appliance is to be moved in the future they must be reattached to lock the drum to prevent an internal damage.

- Always take care when moving the appliance as it is heavy. Always use safety gloves and enclosed footwear.
- Do not install or use a damaged appliance.
- Do not install the appliance where the appliance door cannot be fully opened.
- Adjust the feet to have the necessary space between the appliance and the flooring.
- When the appliance is in its permanent position, check if it is levelled correctly with the aid of a spirit level. If it is not, adjust the feet accordingly.

Transport and storage

- Products must be transported in the original packaging in a vertical position.
- During transport and storage, protect the product from weathering and mechanical damage.
- Products should be stored in a packed form in heated rooms at a temperature from plus 5 °C to plus 40 °C.

Electrical Connection

 **Warning!** Risk of fire and electric shock.

- The appliance must be earthed.
- Always use a correctly installed shockproof socket.
- Do not use multi-plug adapters and extension cables.
- Do not pull the mains cable to disconnect the appliance. Always pull the mains plug.
- Do not touch the mains cable or the mains plug with wet hands.

Water Connection

- The inlet water shall not exceed 25 °C.
- Do not cause damage to the water hoses.
- Before connection to new pipes, pipes not used for a long time, where repair work has been carried out or new devices fitted (water meters, etc.), let the water flow until it is clean and clear.
- Ensure that there are no visible water leaks during and after the first use of the appliance.
- Do not use an extension hose if the inlet hose is too short. Contact the Authorised Service Centre for the replacement of the inlet hose.
- When unpacking the appliance, it is possible to see water flowing from the drain hose. This is due to the testing of the appliance with the use of water in the factory.
- You can extend the drain hose to maximum 400 cm. Contact the Authorised Service Centre for the other drain hose and the extension.
- Make sure that there is access to the tap after the installation.

Use

 **Warning!** Risk of injury, electric shock, fire, burns or damage to the appliance.

- Do not put flammable products or items that are wet with flammable products in, near or on the appliance.

- Do not touch the glass door while a programme operates. The glass can get hot.
- Do not dry damaged (torn, frayed) items that contain padding or fillings.
- If laundry has been washed with a stain remover, carry out an additional rinse cycle before starting a drying cycle.
- Make sure that all metal objects are removed from the laundry.
- Dry only fabrics that are suitable to dry in the appliance. Follow the cleaning instruction on the item label.
- Do not sit or stand on the open door of the appliance.
- Do not dry dripping wet clothes in the appliance.
- Do not let hot items to touch the plastic parts of the appliance.
- Remove a detergent ball (if used) before starting a drying programme.
- Do not use a detergent ball if setting a non-stop programme.

Service

- To repair the appliance contact the Authorised Service Centre. Use original spare parts only.
- Please note that self-repair or non-professional repair can have safety consequences and might void the guarantee.
- Concerning the lamp(s) inside this product and spare part lamps sold separately: These lamps are intended to withstand extreme physical conditions in household appliances, such as temperature, vibration, humidity, or are intended to signal information about the operational status of the appliance. They are not intended to be used in other applications and are not suitable for household room illumination.

Disposal

- Disconnect the appliance from the mains electrical and water supplies.
- Cut off the mains electrical cable close to the appliance and dispose of it.

- Remove the door catch to prevent children or pets from becoming trapped in the drum.
- Dispose of the appliance in accordance with local requirements for the disposal

of Waste Electrical and Electronic Equipment (WEEE).

Product description

Appliance overview

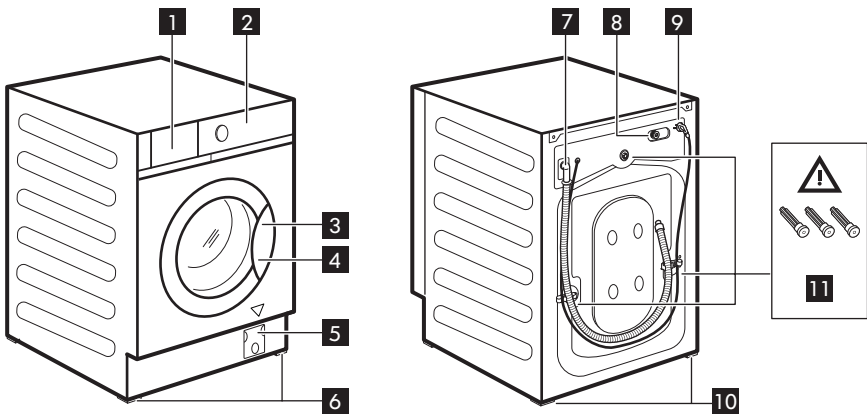

- 1** Detergent dispenser drawer
- 2** Control panel
- 3** Door handle
- 4** Rating plate
- 5** Drain pump filter
- 6** Front feet for levelling the appliance
- 7** Drain hose
- 8** Inlet hose connection
- 9** Mains cable
- 10** Back feet for levelling the appliance
- 11** Transit bolts

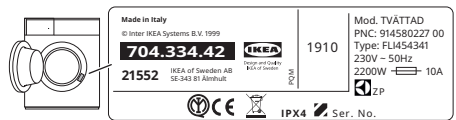

Warning! Before using the appliance, make sure that transit bolts **11** are removed.

Rating plate position **4**

The data in the following drawing are indicative only. Please check the rating plate of your appliance.

Technical Data

Model name		BWD TVAT 8 WH
Dimension	Width/ Height/ Total depth	59.6 cm /81.9 cm /55.3 cm
Electrical connection	Voltage Overall power Fuse Frequency	230 V 2000 W 10 A 50 Hz
Level of protection against ingress of solid particles and moisture ensured by the protective cover, except where the low voltage equipment has no protection against moisture		IPX4
Water supply ¹⁾		Cold water
Water supply pressure	Minimum Maximum	0.5 bar (0.05 MPa) 8 bar (0.8 MPa)
Maximum wash load	Cotton	8 kg
Maximum dry load	Cotton Synthetics	4 kg 3 kg
Spin Speed	Maximum spin speed	1551 rpm

1) Connect the water inlet hose to a water tap with a 3/4" thread.

Electrical connection

At the end of installation you can connect the mains plug to the mains socket.

The rating plate and the 'Technical Data' chapter indicate the necessary electrical ratings. Make sure that they are compatible with the mains power supply.

Check that your domestic electrical installation can take the maximum load required, also taking into account any other appliances in use.

Connect the appliance to an earthed socket.

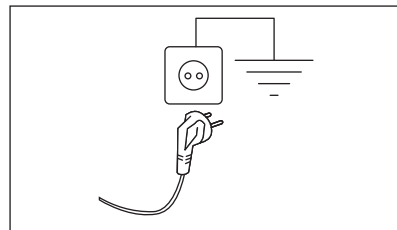

The power supply cable must be easily accessible after installing the appliance.

For any electrical work required to install this appliance, contact our Authorised Service Centre.

The manufacturer does not accept any responsibility for damage or injury through failure to comply with the above safety precaution.

Inspection check list

⚠ Warning! Refer to Safety chapters.

Please follow the inspection check list before using your appliance.

Topics	If the answer is YES <input checked="" type="checkbox"/> , no action is needed	If the answer is NO, please
The appliance is built in the furniture following the assembly instructions. It is NOT positioned free-standing.	<input type="checkbox"/>	Install it in the furniture as required. Refer to assembly instruction.
Open and close the detergent dispenser drawer: no collision with furniture.	<input type="checkbox"/>	Refer to 'Filling the detergent and additives' section.
Drain hose correctly connected to the drainage.	<input type="checkbox"/>	Refer to hoses connection description in the assembly instruction.
No water leakage around the hose connections.	<input type="checkbox"/>	Refer to water connection warning in the assembly instruction.
The appliance is connected to an earthed socket.	<input type="checkbox"/>	Refer to 'Electrical connection' section.
The appliance is stable and levelled properly.	<input type="checkbox"/>	Refer to 'Installation' section.
Hoses and mains cable are not kinked.	<input type="checkbox"/>	Refer to 'Electrical connection' and 'Water connection' section.
There is no carpet under the appliance.	<input type="checkbox"/>	Remove the carpet.

i Please write down the product model name, article number and serial number here below and attach your receipt to this page.

Model (Mod.):

Article number (Art.No.):

Serial number (Ser.No.):

Art. No.
Mod.

21552
IEEA of Sweden AB
SE-146 03 Årstad

IPX4 Ser.No.

Ser. No.

First use

i During installation or before first use you may observe some water in the appliance. This is a residual water left in the appliance after a full functional test in the factory to ensure the appliance is delivered to customers in perfect working order and is no cause for concern.

1. Make sure that the electrical power is available and the water tap is open.

2. Pour 2 litres of water into the detergent compartment marked by **III**.

This action activates the drain system.

3. Pour a small quantity of detergent into the compartment marked by **II**.

4. Set and start a programme for cotton at the highest temperature without any laundry in the drum.

This removes all possible dirt from the drum and the tub.





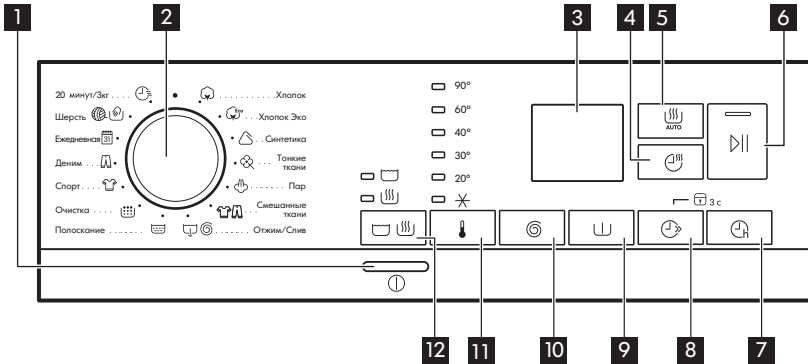



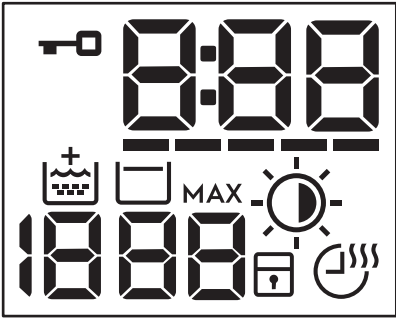

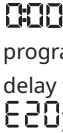







Control panel







Control panel description



















i The options/functions are not available with all washing programmes. Check the compatibility between options/functions and washing programmes in the "Programme Chart". An option/function can exclude another one, in this case the appliance doesn't allow you to set incompatible options/functions.

<p>1</p>	<p>ⓘ On/Off button</p>	<p>Press this button for a few seconds to activate or deactivate the appliance. Two different tunes sound while switching the appliance on or off. As the Stand-by function automatically deactivates the appliance after several minutes to reduce the energy consumption, press this button to activate the appliance again. For more details, refer to 'Stand-by function' paragraph in 'Daily Use' chapter.</p>
<p>2</p>	<p>Programme knob</p>	<p>Turn the selector knob to select the desired programme.</p>
<p>3</p>	<p>Display</p>	 <p>The image shows a digital display with several icons and numbers. At the top left is a key icon. To its right are the digits '0:00'. Below these are three horizontal bars. Further down, there is a crown icon, a square icon, the word 'MAX', a sun icon, and a lock icon. At the bottom, there are the digits '1888', a lock icon, and a sound icon.</p>

		<ul style="list-style-type: none"> •  Door locked indicator: <ul style="list-style-type: none"> - Indicator on: the door cannot be opened. The appliance is working or has stopped with water left in the tub. - Indicator off: the door can be opened. The programme is finished or the water has been emptied out. •  The digital indicator can show: reset position (— — —); programme duration (e. g. 2:40 washing and/or drying cycle); delay time (e. g. 2h); cycle end (); warning code (e.g. E20); error indicator (— — —). •  FlexTime indicator. •  Extra Rinse indicator. •  Spin speed indicator. <ul style="list-style-type: none"> - - - No Spin indicator. Spin phase is off. •  Rinse Hold indicator. • MAX After the AutoAdjust System detection, it flashes when the laundry load exceeds the maximum declared load of the selected programme. Refer to "The AutoAdjust System load detection " paragraph. •  Auto Dry indicator:  Iron dry,  Cupboard dry,  Extra dry. •  Child safety lock indicator. •  Time Dry and Non-Stop programme indicator.
<p style="text-align: center;">4</p>	 Time Dry touch button	Touch this button to set the time that suits the fabrics you have to dry (refer to "Timed drying" table). The display shows the set value. Each time you touch this button the time value increases by 5 minutes. <ul style="list-style-type: none"> •  You cannot set all time values for different types of fabrics.
<p style="text-align: center;">5</p>	 Auto Dry touch button	Touch this button to set one the automatic dryness levels proposed by the appliance. On the display the relevant dryness indicator goes on: <ul style="list-style-type: none"> •  Iron dry: laundry to be ironed. •  Cupboard dry: laundry to be put in store. •  Extra dry: laundry to be fully dried. <ul style="list-style-type: none"> •  You can not set all automatic levels for each type of fabrics.

<p>6</p>	 Start/Pause touch button	<p>This button allows you to start or to pause the selected washing programme.</p>
<p>7</p>	 Delay Start touch button	<p>With this option you can delay the start of a programme to a more convenient time. Touch the button repeatedly to set the required delay. The time increases in steps of 1 hour up to 20 hours.</p>
<p>8</p>	 FlexTime touch button	<p>This option reduces the programme duration depending on the load size and the degree of soiling. When you set a washing programme, the display shows the default duration and the dashes -----. Tap on this button to reduce the programme duration according to your needs. The display shows the new programme duration and a number of dashes will decrease accordingly: ----- suitable for a full load of normally soiled garments. ---- a quick cycle for a full load of lightly soiled garments. --- very quick cycle for a smaller lightly soiled load (max. half load recommended). - the shortest cycle to freshen up a small amount of laundry.</p>
	FlexTime touch button & Steam programme	<p>When setting a steam programme, this button allows to chose three steam levels and the programme duration is reduced accordingly:</p> <ul style="list-style-type: none"> • ---- : maximum. • --- : medium. • - : minimum.
	Permanent Child Lock option  3s	<p>Hold pressed the button  for 3 seconds to set the Child Lock option  3s. This option prevents children from playing with the control panel: all controls are disabled. To deactivate this option, hold this button pressed for 3 seconds.</p>
<p>9</p>	 Prewash touch button	<p>This option adds a pre-wash phase at 30 °C before the washing phase. This option is recommended for heavily soiled laundry, especially if containing sand, dust, mud and other solid particles.</p>

	<p>Permanent Extra Rinse </p>	<p>With this option you can permanently have an extra rinse when you set a new programme.</p> <p>To activate/deactivate this option, hold the button  pressed for 3 seconds until the indicator  comes on/goes off on the display.</p> <p>When it is activated, the appliance will default to this option after you switch it off or change/reset the programme.</p> <p> This option increases the programme duration.</p>
<p>10</p>	<p> Spin and additional options touch button</p>	<p>When you set a programme, the appliance automatically sets the maximum spin speed allowed, except for programme Denim. With this option you can decrease the default spin speed. Touch repeatedly this button to:</p> <ul style="list-style-type: none"> • Decrease the spin speed. The display shows only the spin speeds available for the set programme. • Additional spin options No Spin - - -. Set this option to deactivate all spin phases. The appliance performs the only draining phase of the selected washing programme. Set this option for very delicate fabrics. The rinses phase uses more water for some washing programmes • Activate the Rinse Hold  option. The final spin is not performed. The water of the last rinse is not drained out to prevent the fabrics from creasing. The washing programme ends with water in the drum. The indicator  is on display. The door stays locked and the drum turns regularly to reduce creasing. You must drain the water to unlock the door. If you touch the button , the appliance performs the spinning phase and drains the water. <p> The appliance empties the water out automatically after 18 hours approximately.</p>
<p>11</p>	<p> Temperature touch button</p>	<p>When you select a washing programme, the appliance automatically proposes a default temperature. With this option you can change the temperature. The indicator of the set temperature comes on. The indicator  = cold water.</p>
<p>12</p>	<p> Mode touch button</p>	<p>Thanks to this button, a cycle can perform:</p> <ul style="list-style-type: none"> • Only washing:  indicator is on (default mode). • Washing and drying:  and  indicators are on. • Only drying:  indicator is on.



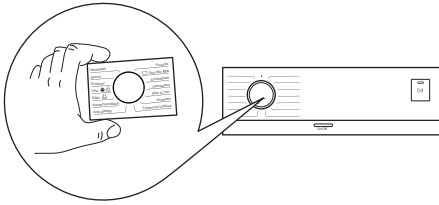

Multilingual badges













Adhesive badges in different languages are supplied with the appliance. The desired badge can be glued around the programme knob.

Programmes

Programme Chart

Programme Default temper- ature Temperature range	Reference spin speed Spin speed range (rpm)	Max. load	Programme description (Type of load and level of soiling)
 Cottons 40 °C 90 °C - Cold	1600 rpm (1600 - 400)	8 kg	White cotton and coloured cotton. Normal and heavy soil.
 Cottons Eco 40 °C 60 °C - 40 °C	1600 rpm (1600 - 400)	8 kg	White cotton and fast-coloured cotton. Normal-ly soiled items. The energy consumption decrea-ses and the time of the washing programme is ex-tended, ensuring good washing results.
 Synthetic 40 °C 60 °C - Cold	1200 rpm (1200 - 400)	3 kg	Synthetic items or mixed fabric items. Normally soiled items.
 Delicates 30 °C 40 °C - Cold	1200 rpm (1200 - 400)	2 kg	Delicate fabrics such as acrylics, viscose and mixed fabrics requiring gentler washing. Nor-mally and lightly soiled items.
 Steam	-	1 kg	Steam programme for cotton and synthetic items. This cycle removes odours from the laun-dry ¹ .



















Programme Default temper- ature Temperature range	Reference spin speed Spin speed range (rpm)	Max. load	Programme description (Type of load and level of soiling)
 Mixed 30 °C 40 °C - Cold	1200 rpm (1200 - 400)	3 kg	Synthetic and mixed fabrics. Normally soiled items.
 Spin/Drain	1600 rpm (1600 - 400)	8 kg	All fabrics, except woollens and delicate fabrics. To spin the laundry and to drain the water in the drum.
 Rinse	1600 rpm (1600 - 400)	8 kg	All fabrics, except woollens and very delicate fabrics. Programme for rinsing and spinning the laundry. The default spin speed is the one used for cotton programmes. Reduce the spin speed according to the type of laundry. If necessary, set the Extra Rinse option to add rinses. With a low spin speed, the appliance performs delicate rinses and a short spin.
 Machine Clean 60 °C	1200 rpm (1200 - 400)	-	Maintenance cycle with hot water to clean and freshen the drum and to remove residue that may cause odour. For the best result use this cycle once a month. Before running this cycle, remove all items from the drum. In the WASH compartment of the detergent dispenser drawer, turn the flap in upward position. Pour a cup of chlorine bleach or a washing machine cleaner in the washing phase compartment. DO NOT use both together.  After the drum cleaning, run a further rinse cycle with empty drum and no detergent to remove any residue of bleach.
 Sport 30 °C 40 °C - Cold	1200 rpm (1200 - 400)	3 kg	Synthetic sport items. This programme is designed to gently wash modern outdoor sportswear and is also suitable for gym, cycling or jogging clothes or similar.
 Denim 30 °C 40 °C - Cold	800 rpm (1200 - 400)	3 kg	Special programme for Denim clothing with delicate washing phase to minimize colour fading and marks. For better care a reduced load size is recommended.

Programme Default temper- ature Temperature range	Reference spin speed Spin speed range (rpm)	Max. load	Programme description (Type of load and level of soiling)
 Express care 40 °C 60 °C - Cold	1200 rpm (1200 -400)	3 kg	Cottons and mixed fabrics. Lightly soiled items. Optimal washing results and perfect fabric care in a short time for your everyday laundry.
 Wool 40 °C 40 °C - Cold	1200 rpm (1200 - 400)	1.5 kg	Machine washable wool, hand washable wool and other fabrics with «hand washing» care symbol ²⁾ .
 20 minutes/3kg 30 °C 40 °C - 30 °C	1200 rpm (1200 - 400)	3 kg	A very short cycle for lightly soiled cotton and synthetic items or worn only once.

1) Steam does not remove animal odours.

2) During this cycle the drum rotates slowly to ensure a gentle wash. It can seem that the drum doesn't rotate or doesn't rotate properly, but this is normal for this programme.

Programme options compatibility

Pro- gramme			 No spin					
	■	■	■	■	■	■	■	■
	■	■	■	■	■	■	■	■
	■	■	■	■	■	■	■	■
	■	■	■	■	■		■	■
						■	■	
	■	■	■	■	■	■	■	■
	■		■				■	
	■	■	■	■	■		■	
	■		■				■	■
	■	■	■	■	■		■	
	■	■	■		■		■	■

Programme								
	■	■	■	■	■		■	
	■	■	■				■	■
	■		■				■	

Suitable detergents for each programme

Programme	Universal powder ¹⁾	Liquid Universal	Liquid for coloureds	Delicates woollens	Special
	▲	▲	▲	--	--
	▲	▲	▲	--	--
	▲	▲	▲	--	--
	--	--	--	▲	▲
	--	▲	▲	--	--
	--	▲	▲	--	▲
	--	--	▲	▲	▲
	--	▲	▲	--	--
	--	--	--	▲	▲
	--	▲	▲	--	--



¹⁾ At temperature higher than 60 °C the use of powder detergent is recommended.

▲ = Recommended

-- = Not recommended

Automatic drying

Dryness Level	Type of fabric	Load
Extra Dry For towelling materials	Cottons and Linen (bathrobes, bath towels, etc)	up to 4 kg
	Denim garments	up to 3 kg

Dryness Level	Type of fabric	Load
 Cupboard Dry For items to be stored	Cottons and Linen (bathrobes, bath towels, etc)	up to 4 kg
	Synthetics and mixed fabrics (jumpers, blouses, underwear, household and bed linen)	up to 3 kg
	Delicate fabrics (acrylics, viscose and delicate mixed fabrics)	up to 2 kg
	Wool items (woollen jumpers)	up to 1 kg
	Denim garments	up to 3 kg
 Iron Dry Suitable for ironing	Cottons and Linen (sheets, tablecloths, shirts, etc)	up to 4 kg

Timed drying

Dryness Level	Type of fabric	Load (kg)	Spin speed (rpm)	Suggested duration (mins)
Extra Dry For towelling materials	Cottons and Linen (bathrobes, bath towels, etc)	4	1600	170 - 190
		2	1600	110 - 120
		1	1600	65 - 75
	Denim garments	3	1200	165 - 175
		1	1200	75 - 85
Cupboard Dry For items to be stored	Cottons and Linen (bathrobes, bath towels, etc)	4	1600	160 - 180
		2	1600	100 - 110
		1	1600	55 - 65
		3	1200	135 - 150
	Synthetics and mixed fabrics (jumpers, blouses, underwear, household and bed linen)			



Dryness Level	Type of fabric	Load (kg)	Spin speed (rpm)	Suggested duration (mins)
		1	1200	45 - 55
	Delicates (acrylics, viscose and delicate mixed fabrics)	2	1200	155 - 165
		1	1200	95 - 105
	Wool (woollen jumpers)	1	1200	80 - 100
	Denim garments	3	1200	155 - 165
		1	1200	65 - 75
Iron Dry Suitable for ironing	Cottons and Linen (sheets, tablecloths, shirts, etc)	4	1600	110 - 125
		2	1600	65 - 75
		1	1600	40 - 50

Settings

Acoustic signals

This appliance has different acoustic signals, that operate when:

- You activate the appliance (special short tune).
- You deactivate the appliance (special short tune).
- You touch the buttons (click sound).
- You make an invalid selection (3 short sounds).
- The programme is completed (sequence of sounds for about 2 minutes).
- The appliance has a malfunction (sequence of short sounds for about 5 minutes).

To **activate/deactivate** the acoustic signals when the programme is completed, touch the  and the  buttons simultaneously for about 2 seconds. The display shows On or Off.



If you deactivate the acoustic signals, they continue to operate when the appliance has a malfunction.

Daily use



Warning! Refer to Safety chapters.

Activating the appliance

1. Connect the mains plug to the mains socket.
2. Open the water tap.
3. Press the On/Off  button for a few seconds to activate the appliance.

A short tune sounds.

Setting a programme

1. Turn the programme knob to select the desired washing programme.

The indicator of Mode Wash button illuminates.

The indicator of the Start/Pause  button flashes.

The display shows an indicative programme duration.

2. To change the temperature and/or the spin speed, touch the related buttons.
3. If desired, set one or more options by touching the related buttons. The related indicators illuminate.

 If a selection is **not possible** an acoustic signal sounds and the display shows - - -.

Loading the laundry

1. Open the appliance door.
2. Empty the pockets and unfold the items before you put them in the appliance.
3. Put the laundry in the drum, one item at a time.

Do not exceed the maximum recommended load for each programme.

4. Close the door firmly.

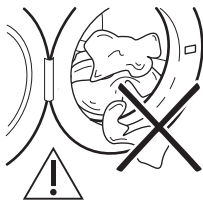

Make sure that no laundry gets caught between the seal and the door to avoid risk of water leakage and damage to the laundry.

 **Warning!** Washing heavily oiled, greasy stains could cause damage to rubber parts of the washing machine.

Filling the detergent and additives

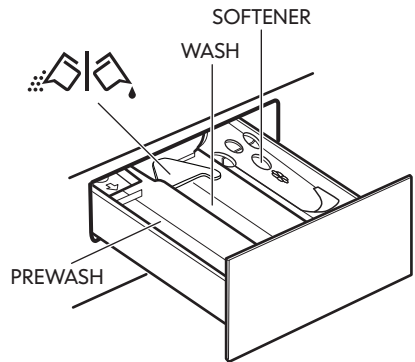

PREWASH - Compartment for prewash phase, soak programme or stain remover.

The prewash and soak detergent is added at the beginning of the wash programme

WASH - Compartment for washing phase.

SOFTENER - Compartment for fabric softener and other liquid treatments (fabric conditioner, starch).

MAX - Maximum level for quantity of liquid additives.

 - Flap for powder or liquid detergent.

English words legend:

- **PUSH** = Push.
- **PREWASH** = Prewash.
- **WASH** = Wash.
- **POSITION USING POWDER DETERGENT** = Position using powder detergent.
- **LIQUID DETERGENT** = Liquid detergent.
- **100 ml** = 100 ml.
- **60 ml** = 60 ml.
- **POSITION USING LIQUID DETERGENT** = Position using liquid detergent.

- **REMOVE TO CLEAN** = Remove to clean.
- **MAX** = Maximum.
- **SOFTENER** = Softener.
- **MAX 100 ml** = Max 100 ml.

i Follow the product manufacturer's recommendations on quantities to use and do not ever exceed the **MAX** mark in the detergent dispenser drawer. To measure out the right quantity of the detergent, see more details in "Degrees of water hardness". Any fabric softener or starching additives must be poured into the compartment before starting the wash programme.

i After a washing cycle, if necessary, remove any detergent residue from the detergent dispenser drawer.

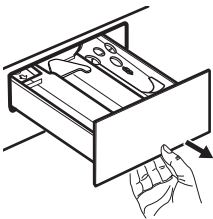

Pull out the detergent dispenser drawer until it stops.

Pour the detergent into the WASH compartment or in the appropriate compartment if it is required by the selected programme/option.

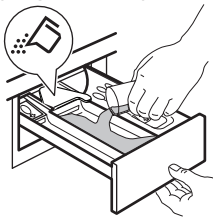

For powder detergent: flap turned upwards.

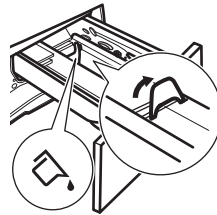

For liquid detergent: flap turned downwards.

With the flap is in the position for liquid detergent:

- Do not use gelatinous or thick liquid detergents.
- Do not exceed to liquid detergent dose indicated on the flap.
- Do not set the pre wash phase.
- Do not set the delay start function.

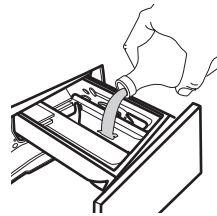

Pour fabric softener into the compartment

marked  (do not exceed the **MAX** mark).

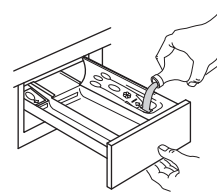

Carefully close the detergent dispenser drawer.

Make sure that the flap does not block the drawer when closing.

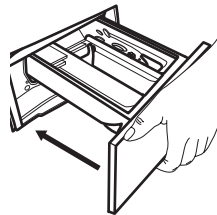

Setting a programme

1. Turn the programme knob to select the desired washing programme. The indicator of Mode Wash button illuminates. The indicator of the Start/Pause  button flashes. The display shows an indicative programme duration.
2. To change the temperature and/or the spin speed, touch the related buttons.

- If desired, set one or more options by touching the related buttons. The related indicators illuminate.

i If a selection is **not possible** an acoustic signal sounds and the display shows **--**.





Starting a programme

Touch the Start/Pause  button to start the programme. The related indicator stops flashing and stays on. It is not possible to start the programme when the indicator of the button is off and doesn't flash (e.g. programme knob on a wrong position). The programme starts, the door is locked.

The display shows the indicator .

i The drain pump can operate shortly before the appliance fills water.





Starting a programme with the delay start

1. Touch the Delay Start  button repeatedly until the display shows the desired delay time. On the display the indicator shows .
2. Touch the Start/Pause  button. The appliance door locks and starts the countdown of the delay start. The display shows the indicator .

When the countdown is completed, the programme starts automatically.



Cancelling the delay start after the countdown has started

To cancel the delay start:

1. Touch the Start/Pause  button to pause the appliance. The related indicator flashes.
2. Touch the Delay Start  button repeatedly until the display shows  and the indicator  goes off.
3. Touch the Start/Pause  button again to start the programme immediately.

Changing the delay start after the countdown has started

To change the delay start:

1. Touch the Start/Pause  button to pause the appliance. The related indicator flashes.
2. Touch the Delay Start  button repeatedly until the display shows the desired delay time.
3. Touch the Start/Pause  button again to start the new countdown.

The AutoAdjust System load detection

i The programme duration in the display is referred to a **medium/high load**.

After touching the Start/Pause  button, the maximum declared load indicator goes off, the AutoAdjust System starts the laundry load detection:



1. The appliance detects the load in the first 30 seconds. In the programmes where FlexTime is available, during this phase the FlexTime bars  placed below the time digits play a simple animation. The drum rotates shortly.
2. The programme duration could be adjusted accordingly and could increase or decrease. After further 30 seconds, the water filling starts.

At the end of the load detection, **in case of drum overload**, the indicator **MAX** is flashing in the display:

In this case, for 30 seconds, it is possible to pause the appliance and remove the exceeding garments.



Once removed the exceeding garments, touch the Start/Pause  button to start the programme again. The AutoAdjust phase can be repeated up to three times (see point 1).

Important! If the laundry amount will not be reduced, the washing programme starts anyway, despite the overload. In this case, it will be not possible to guarantee the best washing results.



-  About 20 minutes after the programme start, the programme duration could be adjusted again depending on the capacity of water absorption of the fabrics.
-  The AutoAdjust detection is carried out with complete washing programmes only and if the programme duration has not been reduced by means of the FlexTime button.
-  The AutoAdjust System is not available with all programmes such as :Wool, Rinse, Spin and programmes with short cycles.

Pausing a programme and changing options

When the programme is running, you can change **only some** options:



1. Touch the Start/Pause  button. The related indicator flashes.
2. Change the options. The given information in the display changes accordingly.
3. Touch the Start/Pause  button again. The washing programme continues.

Cancelling a running programme

1. Press the button On/Off  to cancel the programme and to deactivate the appliance.
2. Press the button On/Off  again to activate the appliance.

-  If the AutoAdjust System has completed and the water filling has already started, the new programme starts **without repeating the AutoAdjust System**. The water and the detergent are not drained out in order to avoid waste.

There is also an alternative way of cancelling:



1. Rotate the programme knob to the "Reset" position  .
2. Wait for 1 second. The display shows  . Now, you can set a new washing programme.



Opening the door

-  **Warning!** If the temperature and level of the water in the drum are too high and/or the drum is still rotating you should not open the door.



While a programme or the delay start operates, the appliance door is locked. The display shows the indicator .

1. Touch the Start/Pause  button. In the display the related door lock indicator goes off.
2. Open the appliance door. If necessary, add or remove the garments. Close the door and touch the Start/Pause  button.

The programme or the delay start continues. The door can be opened when the programme is completed, or set the programme   to drain the water and then touch the Start/Pause  button.

End of the programme

When the programme has finished, the appliance stops automatically. The acoustic

signals operate (if they are active). The display shows 

The indicator of the Start/Pause  button goes off.

The door unlocks and the indicator  goes off.

1. Press button On/Off  to deactivate the appliance.



After five minutes from the end of the programme, the energy saving function automatically deactivates the appliance.

 When you activate the appliance again, the display shows the end of the previous programme. Turn the programme knob to set a new cycle.

2. Remove the laundry from the appliance.
3. Make sure that the drum is empty.
4. Keep the door and the detergent dispenser drawer slightly ajar to prevent mildew and odours.

Draining water out after end of cycle



If you have chosen a programme or an option that does not empty out the water of the last rinse, the programme is completed, but:



- The time area shows  and the display shows the door locked .
- The indicator of the Start/Pause  button starts flashing.
- The drum still turns at regular intervals to prevent creases in the laundry.
- The door stays locked.
- You must drain the water to open the door:

1. If necessary, touch the Spin  button to decrease the spin speed proposed by the appliance.

2. Press the Start/Pause  button: the appliance drains the water and spins.



The option indicator  or  goes off.

 If you have set  and the spin speed has not been changed, when you press the Start/Pause  button, the appliance only drains the water.

3. When the programme is completed and the door locked indicator  goes off, you can open the door.
4. Press the On/Off  button for a few seconds to deactivate the appliance.

Stand-by function

The Stand-by function automatically deactivates the appliance to reduce the energy consumption when:

- You do not use the appliance for 5 minutes when no programme is running. Press the On/Off  button to activate the appliance again.
- 5 minutes after the end of the washing programme. Press the On/Off  button to activate the appliance again. The display shows the end of the last programme. Turn the programme knob to set a new cycle.

If the programme knob is rotated to the "Reset" position  , the appliance automatically turns off in 30 seconds.



 If you set a programme or an option that ends with water in the drum, the Stand-by function **doesn't deactivate** the appliance to remind you to drain the water.

Daily use - Washing & Drying







 **Warning!** Refer to Safety chapters.

 This appliance is an automatic washer dryer.





Complete wash&dry programme

In some washing programmes, you can combine the washing mode  and the drying mode  for running a complete wash&dry programme.

Proceed as follows:

1. Press the On/Off button  for some seconds to activate the appliance.
2. Load the laundry one item at a time.
3. Put the detergent and the additives in the appropriate compartment.
4. Turn the programme dial to the washing programme. The appliance defaults to the washing only mode and the indicator of the  button is on. The display shows the default temperature and spin. If necessary, change them according to your laundry.
5. Set the desired options, if there are available.
6. Tap on the Mode button   once to activate also the drying function. Both indicators  and  are on. The indicator  appears on the display.

Washing and Drying - Automatic levels

1. Tap on the Auto Dry  button repeatedly until the display shows the required dryness level. The indicators in the display illuminate accordingly:
 - a.  **Iron dry:** for cotton items;
 - b.  **Cupboard dry:** for cotton and synthetic items;
 - c.  **Extra dry:** for cotton items.

The time value on the display is the duration of both cycles washing and drying, calculated on a default load size.



 To have a good drying by using less energy and in a shorter time, the appliance does not let you set a too low spin speed for the items to be washed and dried.

2. Touch button Start/Pause  to start the programme. The AutoAdjust estimation starts.

In the display the door locked  indicator comes on.

The display also shows the remaining programme time.

Washing and Timed Drying

1. Tap on the Time Dry  button repeatedly to set the desired time value (see the "Timed drying" table the "Programmes" chapter). The drying level indicator  goes off and the indicator  comes on.



Each time you tap on this button the time value increases by 5 minutes. The display shows the set new time value.



2. Touch the Start/Pause  button to start the programme. The AutoAdjust estimation starts.

In the display the door locked  indicator comes on.

The display also shows the remaining programme time.

At the end of the drying programme

- The appliance stops automatically.
- The acoustic signals operate (if they are active).
- In the display  comes on.
- The indicator of the Start/Pause  button goes off. The door locked  indicator goes off and the door unlocks.

- Press the On/Off button  for some seconds to deactivate the appliance.
-  After some minutes from the end of the programme, the energy saving function deactivates the appliance automatically.



1. Remove the laundry from the appliance.
 2. Make sure that the drum is empty.
-  After drying phase, clean the drum, the seal and the inside of the door with a wet cloth.

Daily use - Drying only

 **Warning!** Refer to Safety chapters.



 This appliance is an automatic washer dryer.

Preparation to drying

1. Press the On/Off button  for some seconds to activate the appliance.
2. Load the laundry one item at a time.
3. Turn the programme dial to the programme suitable for the items to dry. The appliance defaults to the washing only mode and the indicator of the Mode Wash button is on.
4. Tap on the Mode button twice to perform drying only. The indicator of Drying Mode  button illuminates and the indicator of Mode Wash  button goes off.

 When drying a big amount of laundry, to have good drying performances, make sure that the laundry itself is not rolled up and that is uniformly distributed in the drum.

Drying - Automatic levels



1. Tap on the Auto Dry  button repeatedly until the display shows the required dryness level. The indicators in the display illuminate accordingly:
 - a.  **Iron dry:** for cotton items;
 - b.  **Cupboard dry:** for cotton and synthetic items;

c.  **Extra dry:** for cotton items.
The display shows the drying programme duration.

2. Touch the Start/Pause  button to start the programme.

In the display the door locked  indicator comes on.
 The display also shows the remaining programme time.

Timed Drying

1. Tap on the Time Dry  button repeatedly to set the desired time value (see the "Timed drying" table the "Programmes" chapter). The drying level indicator  goes off and the indicator  comes on.





Each time you tap on this button the time value increases by 5 minutes. The display shows the set new time value.

2. Touch the Start/Pause  to start the programme.

In the display the door locked  indicator comes on.
 The display also shows the remaining programme time.

At the end of the drying programme

- The appliance stops automatically.
- The acoustic signals operate (if they are active).
- In the display  comes on.

- The indicator of the Start/Pause  button goes off. The door locked  indicator goes off and the door unlocks.
 - Press the On/Off button  for some seconds to deactivate the appliance.
-  After some minutes from the end of the programme, the energy saving function deactivates the appliance automatically.

1. Remove the laundry from the appliance.
2. Make sure that the drum is empty.

 After drying phase, clean the drum, the seal and the inside of the door with a wet cloth.

Fluff in the fabrics

During the washing and/or drying phase, some types of fabric, (sponge, wool, sweatshirt) could release fluff.



The released fluff could stick to the fabrics during the next cycle.

This inconvenient increases with technical fabrics.

To prevent the fluff in your laundry, we recommend that you:

- To do not wash dark fabrics after you washed and dried light coloured fabrics (hand towel, wool, sweatshirt) and the contrary.
- To dry this type of fabrics at open air when they are washed the first time.
- To clean the drain filter.
- After the drying phase, clean the empty drum, the gasket and the door with a wet cloth.

To remove the fluff inside the drum, set a special programme:

- Empty the drum.
- Clean the drum, the gasket and the door with a wet cloth.
- Set the Machine Clean  programme and the Drying Mode  together to activate the anti-fluff action.
- Touch the Start/Pause  button to start the programme.

 If the appliance is frequently used, carry out the cleaning programme regularly.

Hints and tips

 **Warning!** Refer to Safety chapters.

The laundry load

- Sort the laundry as follows: white, coloured, synthetics, delicates and wool.
- Follow the washing instructions on the laundry care labels.
- Do not wash white and coloured items together.
- Some coloured items can discolour with the first wash. We recommend that you wash them separately for the first couple of times.
- Button up pillowcases, close zippers, hooks and poppers. Tie up belts.
- Turn multilayered fabrics, wool and items with printed illustrations inside out.
- Pre-treat tough stains.
- Wash heavy soil stains with a special detergent.

- Be careful with curtains. Remove the hooks and put the curtains in a washing bag or pillowcase.
- Do not wash laundry without hems or with cuts.
- Use a washing bag to wash small and/or delicate items (e.g. underwired bras, belts, tights, etc.).
- Avoid washing garments full of long animal hair or poor quality garments releasing lots of fluff that could block the drain circuit and therefore requiring the Service assistance.

Stubborn stains

For some stains, water and detergent is not sufficient.

We recommend that you pre-treat these stains before you put the items in the appliance.

Special stain removers are available. Use the special stain remover that is applicable to the type of stain and fabric.

Do not spray stain remover on garments near the appliance as it is corrosive to the plastic parts.

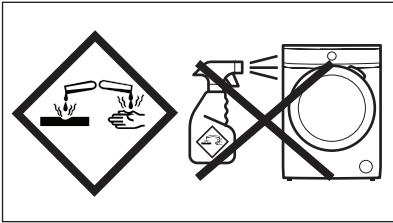

Detergent type and quantity

The choice of detergent and use of correct quantities not only affects your wash performance, but also helps to avoid waste and protect the environment:

- Use only detergents and other treatments specially made for washing machines. First, follow these generic rules:
 - powder detergents for all types of fabric, excluding delicate. Prefer

- liquid detergents, preferably for low temperature wash programmes (60 °C max) for all types of fabric, or special ones for woollens only.
- The choice and quantity of detergent will depend on: type of fabric (delicates, woollens, cottons, etc), the colour of clothes, size of the load, degree of soiling, wash temperature and hardness of the water used.
- Follow the instructions that you find on packaging of the detergents or other treatments without exceeding the indicated maximum level (**MAX**).
- Do not mix different types of detergents.
- Use less detergent if:
 - you are washing a small load,
 - the laundry is lightly soiled,
 - there is large amounts of foam during washing.
- When using detergent tabs or pods, always put them inside the drum, not in the detergent dispenser.

Insufficient detergent may cause:

- unsatisfactory washing results,
- the wash load to turn grey,
- greasy clothes,
- mould in the appliance.

Excessive detergent may cause:

- sudsing,
- reduced washing effect,
- inadequate rinsing,
- a greater impact for the environment.

Ecological hints

To save water, energy and to help protect the environment, we recommend that you follow these tips:

- **Normally soiled laundry** may be washed **without prewash** in order to save detergent, water and time (the environment is protected too!).
- Loading the appliance to the **maximum capacity indicated for each programmes helps to reduce energy and water consumption.**

- With adequate pre-treatment, stains and limited soiling can be removed; the laundry can then be washed at a lower temperature.
- To use the correct quantity of detergent, refer to the quantity suggested by the detergent producer and check the water hardness of your domestic system. Refer to 'Water hardness'.
- Set the **maximum possible spin speed** for the selected programme for saving energy during drying phase!

Degrees of water hardness

Water hardness is classified in so-called “degrees” of hardness. Information on hardness of the water in your area can be obtained from the relevant water supply company, or from your local authority.

Characteris- tic	Degrees of water hard- ness	
	German °dH	French °T.H.
Soft	0-7	0-15
Medium	8-14	16-25
Hard	15-21	26-37
Very hard	> 21	> 37

 A water softener must be added when water has a medium-high degree of hardness. Follow the manufacturer’s instructions. The quantity of detergent can then always be adjusted (reduced) to degree of hardness soft.

Prepare the drying cycle

- Open the water tap.
- Check if the drain hose is connected properly. Refer to installation chapter for more information.
- For the maximum laundry load of the drying programmes, refer to the drying programmes table.





Items not suitable for drying

Do not set a drying programme for this laundry:

- Synthetic curtains.
- Pieces of clothing with metal inserts.
- Nylon stockings.
- Quilts.
- Bed covers.
- Duvets.
- Anoraks.
- Sleeping bags.
- Fabrics with residue of hair sprays, nail solvents or similar.
- Garments with foam-rubber or materials similar to foam-rubber.

Garment labels

When you dry the laundry, obey the indications on the labels of the manufacturers:

-  = The item can be tumble dried
-  = The drying cycle is at high temperature
-  = The drying cycle is at reduced temperature
-  = The item can not be tumble dried.

Drying cycle duration

The drying time can change depending on:

- speed of the last spin
- dryness level
- type of laundry
- weight of the load

Additional drying

If, at the end of the drying programme, the laundry is still damp, set a short drying cycle again.



Warning! To avoid creasing and shrinkage do not overdry the laundry.

General Tips

Refer to the «Drying programmes» table to find the **average** drying times.

Experience will help you to dry the laundry better. Take note of the duration of the cycles done before.

To avoid the static charge at the end of the drying cycle:

1. Use fabric conditioner in the washing cycle.
2. Use special fabric conditioner for tumble dryers.

When the drying programme is completed remove the laundry promptly.

Care and cleaning

 **Warning!** Refer to Safety chapters.

Periodic cleaning schedule

Periodic cleaning helps to extend the life of your appliance.

After each cycle, keep the door and the detergent dispenser slightly ajar to get air circulation and dry the humidity inside the appliance: this will prevent mildew and odours.

If the appliance is not used for a long time: close the water tap and unplug the appliance.

Indicative periodic cleaning schedule:

Descaling	Twice a year
Maintenance wash	Once a month
Clean door seal	Every two months
Clean drum	Every two months
Remove fluff inside the drum	Twice a month ¹⁾
Clean detergent dispenser	Every two months
Clean drain pump filter	Twice a year
Clean the inlet hose and the valve filter	Twice a year

1) Refer to "Fluff in the fabrics" chapter.

The following paragraphs explain how you should clean each part.

Removing foreign objects

-  Make sure that pockets are empty and all loose elements are tied up before running your cycle. Refer to 'The laundry load' in 'Hints and tips'.

Remove any foreign objects (such as metal clip, buttons, coins, etc) that you may find in the door seal, the filters and the drum. Refer to 'Door seal with double lip trap', 'Cleaning the drum', 'Cleaning the drain pump' and 'Cleaning the inlet hose and the valve filter' paragraphs. If necessary, please contact the Authorised Service Centre.

External cleaning

Clean the appliance with mild soap and warm water only. Fully dry all the surfaces. Do not use a scouring pads or any scratching material.

 **Caution!** Do not use alcohol, solvents or chemical products.

 **Caution!** Do not clean the metal surfaces with chlorine-based detergent.

Descaling

i If the water hardness in your area is high or moderate, we recommend that you use a water descaling product for washing machines.

Regularly examine the drum to check for limescale.

Regular detergents already contain water softening agents, but we recommend to run a cycle with an empty drum and a descaling product.

i Always follow the instructions that you find on the packaging of the product.

Maintenance wash

The repeated and prolonged use of low temperature programmes can cause detergent deposits, fluff residues, bacterial growth inside the drum and the tub. This could generate bad odours and mildew. To eliminate these deposits and clean the inner part of the appliance, run a maintenance wash regularly (at least once a month).

i Refer to "Cleaning the drum" paragraph.

Door seal

Regularly examine the seal of the door and remove all objects from the inner part.

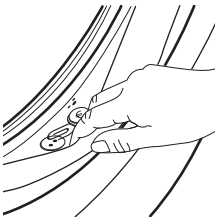

Cleaning the drum

Regularly examine the drum to prevent unwanted deposits.

Rust deposits in the drum may occur due to rusting foreign body in the washing or tap water containing iron

Clean the drum with special products for stainless steel.

i Always follow the instructions that you find on the packaging of the product. Do not clean the drum with acidic descaling products, scouring products containing chlorine or iron or steel wool.

For a thorough clean:

1. Remove all laundry from the drum.
2. Run the Machine Clean  programme. For more details, refer to washing programme table.
3. Add a small quantity of powder detergent into the empty drum, in order to rinse out any left residues.

Cleaning the detergent dispenser drawer and the drawer recess

The detergent dispenser drawer should be cleaned regularly to remove possible deposits of dried detergent or clotted fabric softener and/or formation of mould. Proceed as follows:

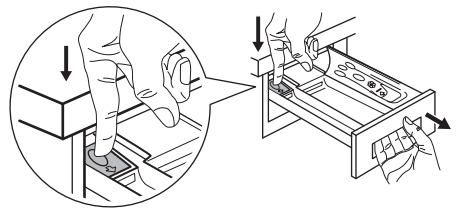

To remove the drawer, press the lever downwards and pull it out.

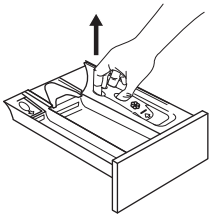

To aid cleaning, remove also the top part of the additive compartment.

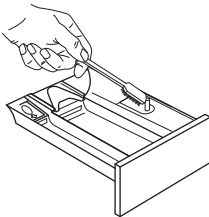

Use a stiff brush to clean and remove all washing powder residue.

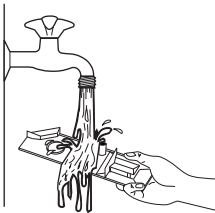

Flush out all the removed parts of the dispenser drawer under a tap to remove any traces of accumulated powder.

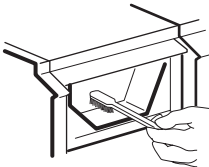

Use the previous brush to clean the recess, ensuring that upper and lower part of it is well cleaned.

After having cleaned the dispenser and the drawer recess, replace it and run a rinse programme without any laundry in the drum to flush away any residue.

Cleaning the drain pump

Warning! Disconnect the mains plug from the mains socket.

i Regularly check the drain pump filter and make sure that it is clean.

Clean the drain pump if:

- The appliance does not drain the water.
- The drum does not turn.
- The appliance makes an unusual noise because of the blockage of the drain pump.
- The display shows the alarm code *E20*.

Warning!

- Do not remove the filter while the appliance operates.
- Do not clean the pump if the water in the appliance is hot. Wait until the water cools down

Proceed as follows to clean the pump:

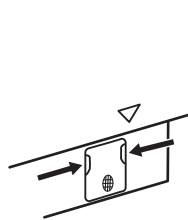

1. Open the pump cover.

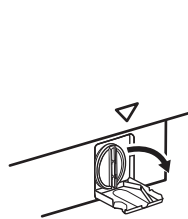

2. Place a suitable bowl below the drain pump access to collect the water that flows out.

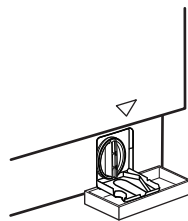

Always keep a rag nearby to dry up any water spillages when removing the filter.

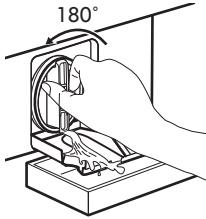

3. Turn the filter 180 degrees in anti-clockwise direction to open it, without removing. Let the water flow out.

4. When the bowl is full of water, turn the filter back and empty the container.

5. Repeat the steps 3 and 4 until the water stops to flow out.

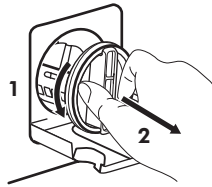

6. Turn the filter anti-clockwise to remove it.

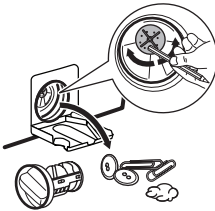

7. If it is necessary, remove fluff and objects from the filter recess. Make sure that the impeller of the pump can rotate. If it does not rotate, contact the Authorised Service Centre.

Make sure that the impeller of the pump can rotate. If it does not rotate, contact the Authorised Service Centre.



8. Clean the filter under the water tap.

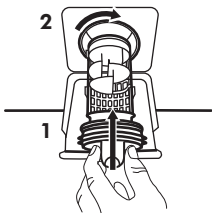

9. Put the filter back into the special guides by turning it clockwise. Make sure that you tighten the filter correctly to prevent leakages.

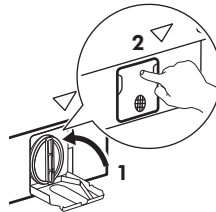

10. Close the pump cover.

When you drain the water with the emergency drain procedure, you must activate the drain system again:

1. Put 2 litres of water in the main wash compartment of the detergent dispenser drawer.
2. Start the programme to drain the water.

Cleaning the inlet filter and the filter valve

If the appliance takes long to fill with water or doesn't fill, the starting button indicator flashes in red. Check if the water inlet filter and the valve filter are blocked (see chapter "Troubleshooting" for more details).

Proceed as follows:

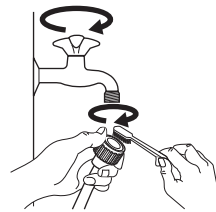

- Turn off the water tap.
- Unscrew the hose from the tap.
- Clean the filter in the hose with a stiff brush.
- Screw firmly the inlet hose back onto the tap.

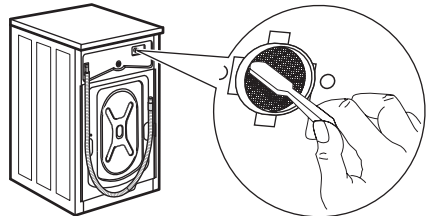

- Unscrew the hose from the appliance. Keep a rag nearby because some water may flow.
- Clean the filter in the valve with a stiff brush or with the piece of cloth.

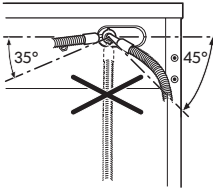

- Screw the hose back to the appliance turning it to the left or the right to suit the installation. Tight the locknut correctly to prevent water leaks.

- Turn on the water tap.

Emergency drain

If the appliance cannot drain the water, carry out the same procedure, described in 'Cleaning the drain pump' paragraph. If necessary, clean the pump.

When you drain the water with the emergency drain procedure, you must activate the drain system again:

1. Put 2 litres of water in the main wash compartment of the detergent dispenser drawer.

2. Start the programme to drain the water.

Frost precautions

If the appliance is installed in an area where the temperature can reach values around 0° C or drop below, remove the remaining water from the inlet hose and the drain pump.

1. Disconnect the mains plug from the mains socket.
2. Close the water tap.
3. Put the two ends of the inlet hose in a container and let the water flow out of the hose.
4. Empty the drain pump. Refer to the emergency drain procedure.
5. When the drain pump is empty, install the inlet hose again.

Warning! Make sure that the temperature is higher than 0 °C before you use the appliance again. The manufacturer is not responsible for damages caused by low temperatures.

Troubleshooting

Warning! Refer to Safety chapters.

Introduction



The appliance does not start or it stops during operation.

First try to find a solution to the problem (refer to the table). If the problem persists, contact the Authorised Service Centre.

Warning! Deactivate the appliance before carrying out any check.

In case of major problems, the acoustic signals operate, the display shows an alarm code and the Start/Pause button may flash continuously:

- **EHO** - The mains supply is unstable. Wait until the mains supply is stable.

- **E91** - No communication between electronic elements of the appliance. Switch it off and switch on again. The programme was not finished properly or the appliance stopped too early. If the alarm code appears again, contact the Authorised Service Centre.
 - **E10** - The appliance does not fill with water properly. After the proper check, start the appliance again by pressing Start/Pause  button the appliance tries to resume the cycle . If the error persists the alarm code will appear again.
 - **E20** - The appliance does not drain the water.
 - **E40** - The appliance door is open or not closed correctly. Please check the door!
- i** If the appliance is overloaded, remove some items from the drum and/or hold the door shut while touching the Start/Pause  button until the indicator  stops flashing (see the picture below).

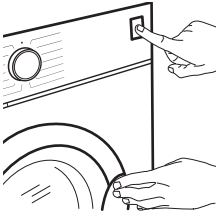

Possible failures

Problem	Possible solution
<p>The programme does not start.</p>	<ul style="list-style-type: none"> • Make sure that the mains plug is connected to the mains socket. • Make sure that the appliance door is closed. E40 • Make sure that there is no damaged fuse in the fuse box. • Make sure that the Start/Pause  has been touched. • If the delay start is set, cancel the setting or wait for the end of countdown. • Deactivate the Child Lock function if it is on. • Check the position of the knob on the selected programme.
<p>The appliance does not fill with water properly. E10</p>	<ul style="list-style-type: none"> • Make sure that the water tap is open. • Make sure that the pressure of the water supply is not too low. For this information, contact your local water authority. • Make sure that the water tap is not clogged. • Make sure that the inlet hose has no kinks, damages or bends. • Make sure that the connection of the water inlet hose is correct. • Make sure that the filter of the inlet hose and the filter of the valve are not clogged. Refer to 'Care and cleaning'.

Problem	Possible solution
The appliance fills with water and drains immediately.	<ul style="list-style-type: none"> • Make sure that the drain hose is in the correct position. The hose may be positioned too low. Refer to "Installation instruction".
The appliance does not drain the water. E20	<ul style="list-style-type: none"> • Make sure that the sink spigot is not clogged. • Make sure that the drain hose has no kinks or bends. • Make sure that the drain filter is not clogged. Clean the filter, if necessary. Refer to "Care and cleaning". • Make sure that the connection of the drain hose is correct. • Set the drain programme if you set a programme without drain phase. • Set the drain programme if you set an option which ends with water in the tub.
The spin phase does not operate or the washing cycle lasts longer than usual.	<ul style="list-style-type: none"> • Set the spin programme. • Make sure that the drain filter is not clogged. Clean the filter, if necessary. Refer to "Care and cleaning". • Adjust manually the items in the tub and start the spin phase again. This problem may be caused by balance problems.
There is water on the floor.	<ul style="list-style-type: none"> • Make sure that the couplings of the water hoses are tight and there is not water leakages. • Make sure that the water inlet hose and the drain hose have no damages. • Make sure you use the correct detergent and the correct quantity of it.
You cannot open the appliance door.	<ul style="list-style-type: none"> • Make sure that a washing programme that ends with water in tub, has been selected. • Make sure that the washing programme is finished. • Set the drain or the spin programme if there is water in the drum. • Make sure that the appliance receives electrical power. • This problem may be caused by a failure of the appliance. Contact the Authorised Service Centre. If you need to open the door, please read carefully "Emergency door opening".
The appliance makes an unusual noise and vibrates.	<ul style="list-style-type: none"> • Make sure the levelling of the appliance is correct. Refer to "Installation instruction". • Make sure that the packaging and/or the transit bolts are removed. Refer to "Installation instruction". • Add more laundry in the drum. The load may be too small. Refer to 'Opening the door' paragraph in 'Daily use' chapter.

Problem	Possible solution
The programme duration increases or decreases during programme execution.	<ul style="list-style-type: none"> The AutoAdjust System is able to adjust the programme duration according to the type and the laundry load size. Refer to "The AutoAdjust System load detection" in "Daily Use" chapter.
The washing results are not satisfactory.	<ul style="list-style-type: none"> Increase the detergent quantity or use a different detergent. Use special products to remove the stubborn stains before you wash the laundry. Make sure that you set the correct temperature. Decrease the laundry load.
Too much foam in the drum during the washing cycle.	<ul style="list-style-type: none"> Reduce the quantity of detergent.
After the washing cycle, there are some detergent residues in the detergent dispenser drawer.	<ul style="list-style-type: none"> Make sure that the flap is in the correct position (UP for powder detergent - DOWN for liquid detergent). Make sure you have used the detergent dispenser drawer according the indications given in this user manual.
The appliance does not dry or does not dry correctly.	<ul style="list-style-type: none"> Turn the water tap on. Make sure the drain filter is not clogged. Reduce the laundry load. Make sure you have set the correct cycle. if necessary, set again a short drying time.
The laundry is full of different colours fluff.	<p>The fabrics washed in the previous cycle released fluff of a different colour:</p> <ul style="list-style-type: none"> The drying phase helps to eliminate some fluff. Clean the clothes with a fluff remover. <p>In case of an excessive amount of fluff in the drum run the special programme to clean it (refer to "Fluff in the fabrics" for more details).</p>

Emergency door opening

In case of power failure or functioning failure the appliance door remains locked. The washing programme continues when the power is restored. If the door remains locked in case of failure, it is possible to open it using the emergency unlock function.

Before opening the door:



Caution! Risk of burns! Make sure that the water temperature is not too high and the laundry is not hot. If necessary, wait until they cool down.



Caution! Risk of injury! Make sure that the drum is not rotating. If necessary, wait until the drum stops rotating.

- i** **Make sure that the water level inside the drum is not too high. If necessary, proceed with an emergency drain (refer to «Emergency drain» in «Care and cleaning» chapter).**

To open the door, proceed as follows:

1. Press the On/Off **Ⓛ** button to switch the appliance off.
2. Disconnect the mains plug from the mains socket.
3. Pull the emergency unlock trigger downward once. Pull it once again, keep it tensed and, in the meanwhile, open the appliance door. The emergency unlock trigger is located where indicated by the following picture.

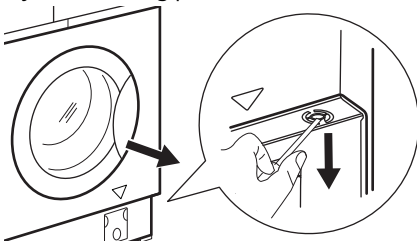

4. Take out the laundry and then close the appliance door.

Service

We recommend the use of original spare parts. After the check, switch on the appliance and press the button **▶||** to restart the programme.

If the problem remains, contact your Authorised Service Centre. The necessary data for the service centre is on the rating plate. Refer to 'Inspection check list' chapter.

Consumption values

- i** Stated values are obtained in laboratory conditions with relevant standards. Different causes can change the data: the quantity and type of laundry and ambient temperature. Water pressure, the supply voltage and the temperature of inlet water may also affect the washing programme duration.
- i** Technical specifications may be changed without prior notice to improve the quality of product.

- i** During the washing programme, the AutoAdjust technology can vary the wash duration and the consumption values. For further details see 'The AutoAdjust load detection' paragraph in 'Daily Use' chapter.

Programmes	Load (kg)	Energy consumption (kWh)	Water consumption (litre)	Approximate programme duration (minutes)
Cottons 60°C	8	1.23	80	215
Cottons Eco 60 °C Cottons energy saving programme	8	0.97	56	285
Cottons 40°C	8	0.89	80	185
Synthetics 40°C	3	0.59	71	135
Delicates 40°C	2	0.30	47	60
Wool/Handwash 30°C	1.5	0.15	58	70

Environmental concerns

Recycle materials with the symbol . Put the packaging in relevant containers to recycle it. Help protect the environment and human health by recycling waste of electrical and electronic appliances. Do not dispose of

appliances marked with the symbol  with the household waste. Return the product to your local recycling facility or contact your municipal office.

Store in a dry place indoors.

The month and year of manufacture of this product are indicated in the serial number, where the first digit of the number corresponds to the last digit of the year of manufacture, and the second and third digits indicate the week number. For example, serial number 14512345 means that the product is made at the forty-fifth week of the year 2021.

Manufacturer: IKEA of Sweden AB, Box 702, 343 81 Älmhult, Sweden

The entity authorized by the manufacturer to take actions in Russia for assessment of the conformity of products: OOO Electrolux Rus, Kozhevicheskii proezd 1, 115114, Moskva; tel.: 8-800-444-444-8, www.electrolux.ru

The importer: LLC "IKEA TORG", bld. 1, microraiion IKEA, Khimki, Moscow region, 141400 Russia, tel.: +(495) 737-5301, fax +(495) 737-5324

For IKEA product quality issues, contact the seller: LLCOOO IKEA DOM, bld. 1, microraiion IKEA, Khimki, Moscow region, 141400 Russia; tel.: +7 (495) 666-2929, www.ikea.ru

Made in Italy

IKEA guarantee

How long is the IKEA guarantee valid?

This guarantee is valid for **5 years** from the original date of purchase of your appliance at IKEA. The original sales receipt is required as a proof of purchase. If service work is carried out under guarantee, this will not extend the guarantee period for the appliance.

Who will execute the service?

An IKEA authorized service partner network will provide the service.

What does this guarantee cover?

The guarantee covers faults of the appliance, which have been caused by faulty construction or material faults from the date of purchase from IKEA. This guarantee applies to domestic use only. The exceptions are specified under the headline "What is not

covered under this guarantee?" Within the guarantee period, the costs to remedy the fault e.g. repairs, parts, labour and travel will be covered, provided that the appliance is accessible for repair without special expenditure and that the fault has been caused by faulty construction or material faults covered by the guarantee. On these conditions the respective local regulations are applicable. Replaced parts become the property of IKEA.

What will IKEA do to correct the problem?

IKEA appointed service provider will examine the product and decide whether it is covered under this guarantee. If considered covered, IKEA service provider or its authorized service partner will then either repair the defective product or replace it with the same or a comparable product.

What is not covered under this guarantee?

- Normal wear and tear;
- Deliberate or negligent damage, damage caused by carelessness, failure to observe operating instructions, incorrect installation or by connection to the wrong voltage; damage caused by chemical or electro-chemical reaction, rust, corrosion or water damage including but not limited to damage caused by excessive lime in the water supply, damage caused by abnormal environmental conditions;
- Consumable parts including batteries and lamps;
- Non-functional and decorative parts which do not affect normal use of the appliance, including any scratches and possible color differences.
- Accidental damage caused by foreign objects or substances and cleaning or unblocking of filters, drainage systems or soap drawers.
- Damage to the following parts: ceramic glass, accessories, crockery and cutlery baskets, feed and drainage pipes, seals, lamps and lamp covers, screens, knobs, casings and parts of casings (these parts will only be covered by the guarantee if the service center confirms that they have been caused by production faults).
- Cases where no fault could be found during a technician's visit.
- Repairs not carried out by our appointed service providers and/or an authorized service contractual partner or where non-original parts have been used.
- Repairs caused by improper installation.
- Damage during the use of the appliance in a non-domestic environment i.e. professional or other use associated with business activities.
- Transportation damages. If a customer transports the product to their home or other address, IKEA is not liable for any damage that may occur during transport. However, if IKEA delivers the product to the customer's delivery address, then damage to the product that occurs during

this delivery will be covered by this guarantee.

- The conditions for the installation of IKEA appliances, except for the cases when installation is required due to repairs or replacement of faulty parts.
- The cost for carrying out the initial installation is not included into the price of the appliance you purchase from IKEA. If an IKEA service provider or its authorized service partner repairs or replaces the appliance under the terms of this guarantee, the service provider or its authorized service partner will re-install the repaired appliance or install the replacement, if necessary. This restriction does not apply to installation carried out by a qualified specialist using our original parts in order to adapt the appliance to the technical safety specifications of another country.

Applicability of national laws

The IKEA guarantee gives you specific legal rights, which cover or exceed local demands, which may differ from country to country.

Area of validity for appliances purchased in Russia

This guarantee applies only to appliances purchased in Russia. An obligation to carry out services in the framework of the guarantee exists only if the appliance was installed in accordance with the following requirements:

- technical specifications of the country in which the guarantee claim is made;
- safety rules stipulated in Assembly Instructions and User Manual.

IKEA authorized service partner

Please do not hesitate to contact IKEA After Sales Service to:

1. make a service request under this guarantee;
2. ask for clarification on installation of the IKEA appliance in the dedicated IKEA kitchen furniture. The service won't provide clarifications related to:
 - the overall IKEA kitchen installation

- connections to electricity (if machine comes without plug and cable), to water and to gas. These works have to be executed by an authorized service engineer
3. ask for clarification on functions and operation of the appliance purchased from IKEA

To ensure that we provide you with the best assistance, please read carefully the accompanying documents and the User Manual before contacting the service.

How to reach us if you need our service



Please refer to the last page of this manual for the full list of IKEA appointed service partners.

- i** In order to provide you with a quicker service, we recommend that you specify the article number (12-digit service code and 8-digit item code) given in this booklet when you call the service. Before calling us, assure that you have to hand the IKEA article number (8 digit code) and the Serial Number (8 digit code that can be found on the rating plate) for the appliance of which you need our assistance.

- i** **YOU MUST SAVE THE SALES RECEIPT!** The sales receipt is your proof of purchase and you must hand it in as you claim guarantee service.

Do you need extra help?

For any additional questions not related to After Sale service, please contact our nearest IKEA store call Centre. We recommend you read the appliance documentation carefully before contacting us.

The service life of this item is 10 years.

After end service life, your product can still be used if you follow the safety information and other instructions in the user manual. When you decide to stop using the product, please contact your local recycling facility to legally destroy the appliance.

Country	Phone number	Call Fee	Opening time
België	070 246016	Binnenlandse gesprekskosten	8 tot 20 Weekdagen
Belgique		Tarif des appels nationaux	8 à 20. En semaine
България	+359 2 492 9397	Според тарифата на оператора за обаждания към стационарен номер	От 8:30 до 17:30 ч в работни дни
Česká Republika	246 019721	Cena za místní hovor	8 až 20 v pracovních dnech
Danmark	70 15 09 09	Landstakst	man. - fre. 09.00 - 20.00 lør. - søn. 09.00 - 18.00
Deutschland	+49 1806 33 45 32*	* 0,20 €/Verbindung aus dem Festnetz max. 0,60 €/Verbindung aus dem Mobilfunknetz	Werktags von 8.00 bis 20.00
Ελλάδα	211 176 8276	Υπεραστική κλήση	8 έως 20 κατά τις εργάσιμες ημέρες
España	91 1875537	Tarifa de llamadas nacionales	De 8 a 20 en días laborables
France	0170 36 02 05	Tarif des appels nationaux	9 à 21. En semaine
Hrvatska	00385 1 6323 339	Trošak poziva 27 lipa po minuti	radnim danom od ponedjeljka do petka od 08:00 do 16:00
Ireland	0 14845915	National call rate	8 till 20 Weekdays
Ísland	+354 5852409	Innanlandsgjald fyrir síma	9 til 18. Virka daga
Italia	02 00620818	Tariffa applicata alle chiamate nazionali	dalle 8 alle 20 nei giorni feriali
Κυπρος	22 030 529	Υπεραστική κλήση	8.30 έως 16.30 κατά τις εργάσιμες ημέρες
Lietuva	5 230 06 99	Nacionalinių pokalbių tarifai	Pr. - Ketv.: 8:00 - 12:00, 12:45 - 17:00 Pnkt.: 8:00 - 12:00, 12:45 - 15:45
Magyarország	06-1-252-1773	Belföldi díjszabás	Hétköznap 8.00 és 17.00 óra között
Nederland Luxembourg	0900 - 235 45 32 (0900-BEL IKEA) 0031 - 50 316 8772 (internationaal)	Geen extra kosten. Alleen lokaal tarief.	ma-vr: 8.00 - 21.00 zat: 9.00 - 21.00 zon / pub. vakantie: 10.00 - 18.00
Norge	22 72 35 00	Takst innland	8 til 20 ukedager
Österreich	+43-1-2056356	max. 10 Cent/min.	Mo - Fr 8.00 - 20.00 Uhr
Polska	+48 22 749 60 99	Koszt zgodny z taryfą operatora	Od 8 do 20 w dni robocze
Portugal	211557985	Chamada Nacional	9 às 21. Dias de Semana *excepto feriados
România	021 211 08 88	Tarif apel național	8 - 20 în zilele lucrătoare
Россия	8 495 6662929	Действующие телефонные тарифы	с 8 до 20 по рабочим дням Время московское
Schweiz	031 5500 324	Tarif für Anrufe im Bundesgebiet	8 bis 20 Werktag
Suisse		Tarif des appels nationaux	8 à 20. En semaine
Svizzera		Tariffa applicata alle chiamate nazionali	dalle 8 alle 20 nei giorni feriali
Slovenija	+38618108621	lokálni strošek je običajna tržna vrednost, odvisna od ponudnika telefonije	8.00 - 16.00 ob delavnikih
Slovensko	(02) 3300 2554	Cena vnitroštátneho hovoru	8 až 20 v pracovných dňoch
Suomi	030 6005203	Lankapuhelinverkosta 0,0835 €/puhelu + 0,032 €/min Matkapuhelinverkosta 0,192 €/min	arkipäivisin 8.00 - 20.00
Sverige	0775 700 500	lokalsamtal (lokal taxa)	mån-fre 8.30 - 20.00 lör-sön 9.30 - 18.00
United Kingdom	020 3347 0044	National call rate	9 till 21. Weekdays
Србија	+381 11 7 555 444 (ако позивате изван Србије) 011 7 555 444 (ако позивате из Србије)	Цена позива у националном саобраћају	Понедељак - субота: 09 - 20 Недеља: 09 - 18
Eesti, Latvija, Україна		www.ikea.com	

157034471-A-132021

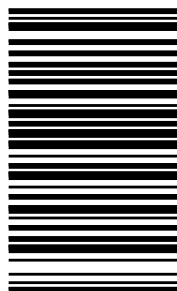

© Inter IKEA Systems B.V. 2021

21552

AA-2227001-3