

STRÅLA

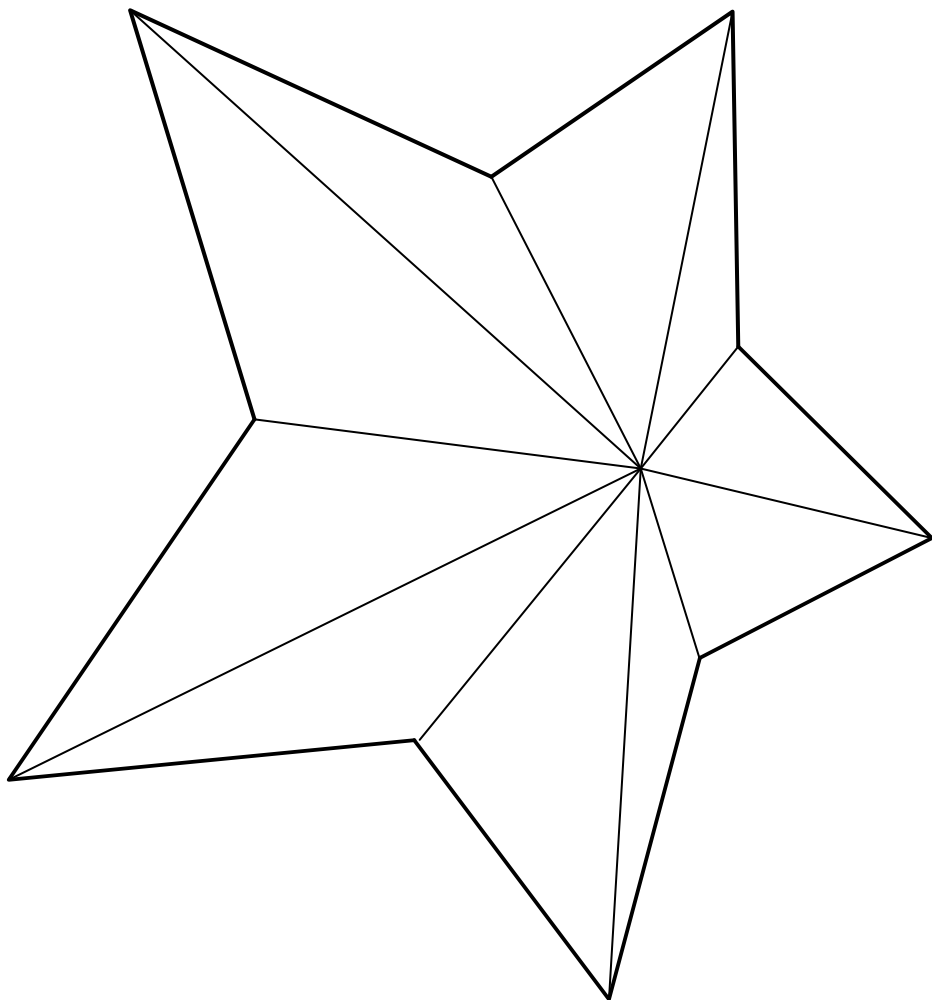

Design and Quality
IKEA of Sweden

**ENGLISH**

The distance between surface of bulb and shade must be at least 30 mm.

DEUTSCH

Der Abstand zwischen der Lichtquelle und dem Schirm muss mindestens 30 mm betragen.

FRANÇAIS

La distance séparant l'ampoule de l'abat-jour doit être d'au moins 30 mm.

NEDERLANDS

De afstand tussen lamp en lampenkap moet minstens 30 mm bedragen.

DANSK

Afstanden mellem pærens overflade og lampeskærmen skal være mindst 30 mm.

ÍSLENSKA

Fjarlægðin á milli perunnar og skermsins verður að vera a.m.k. 30 mm.

NORSK

Avstanden mellom overflaten på ei pære og skjermen må være minst 3 cm.

SUOMI

Etäisyyden lampun pinnan ja varjostimen välillä täytyy olla vähintään 30 mm.

SVENSKA

Avståndet mellan ljuskälla och skärm måste vara minst 30 mm.

ČESKY

Vzdálenost mezi žárovkou a stínidlem musí činit nejméně 30 mm.

ESPAÑOL

La distancia entre la bombilla y la pantalla debe ser de 30 mm como mínimo.

ITALIANO

La distanza tra la superficie della lampadina e quella del paralume deve essere di almeno 30 mm.

MAGYAR

Az izzó felülete és a lámpaernyő közötti távolság legalább 30 mm legyen.

POLSKI

Odległość pomiędzy powierzchnią żarówki a kloszem musi wynosić co najmniej 30 mm.

EESTI

Lambipirni pinna ja kupli kaugus teineteisest peab olema vähemalt 30 mm.

LATVIEŠU

Attālumam starp spuldzes virsmu un lampas abažūru jābūt vismaz 30 mm.

LIETUVIŲ

Atstumas nuo lemputės (paviršiaus) iki gaubto turi būti mažiausiai 30 mm.

PORTUGUÊS

A distância entre a superfície da lâmpada e o abajur deve ser de cerca de 30 mm.

ROMÂNĂ

Distanța dintre bec și abajur trebuie să fie de cel puțin 30mm.

SLOVENSKY

Vzdialenosť medzi povrchom žiarovky a tienidlom musí byť aspoň 30 mm.



БЪЛГАРСКИ

Разстоянието между повърхността на крушката и абажура трябва да бъде поне 30 мм.

HRVATSKI

Udaljenost između površine žarulje i sjenila mora biti barem 30 mm.

ΕΛΛΗΝΙΚΑ

Η απόσταση μεταξύ της επιφάνειας του λαμπτήρα και του καπέλου πρέπει να είναι τουλάχιστον 30 mm.

РУССКИЙ

Расстояние от поверхности лампы до абажура должно быть не меньше 30 мм.

SRPSKI

Razmak između sijalice i abažura mora biti najmanje 30 mm.

SLOVENŠČINA

Razdalja med površino žarnice in senčnikom mora biti najmanj 30 mm.

TÜRKÇE

Ampul ve abajur arasındaki mesafe en az 30 mm olmalıdır.

中文

灯泡表面与灯罩之间需保持至少 30 毫米的距离。

繁体

燈泡表面與燈罩之間須保持至少3公分的距離。

한국어

전구와 전등갓은 최소 30mm의 간격을 두어야 합니다.

日本語

電球表面とシェードの間の距離は 30mm 以上必要です。

BAHASA INDONESIA

Jarak antara permukaan bohlam dan kap setidaknnya harus 30 mm.

BAHASA MALAYSIA

Jarak antara permukaan mentol dan terendak seharusnya pada sekurang-kurangnya 30 mm.

عربي

يجب أن تكون المسافة بين سطح اللمبة والغطاء 30 ملم على الأقل.

ไทย

หลอดไฟและโคมควรมีระยะห่างจากกันอย่างน้อย 30 มม.

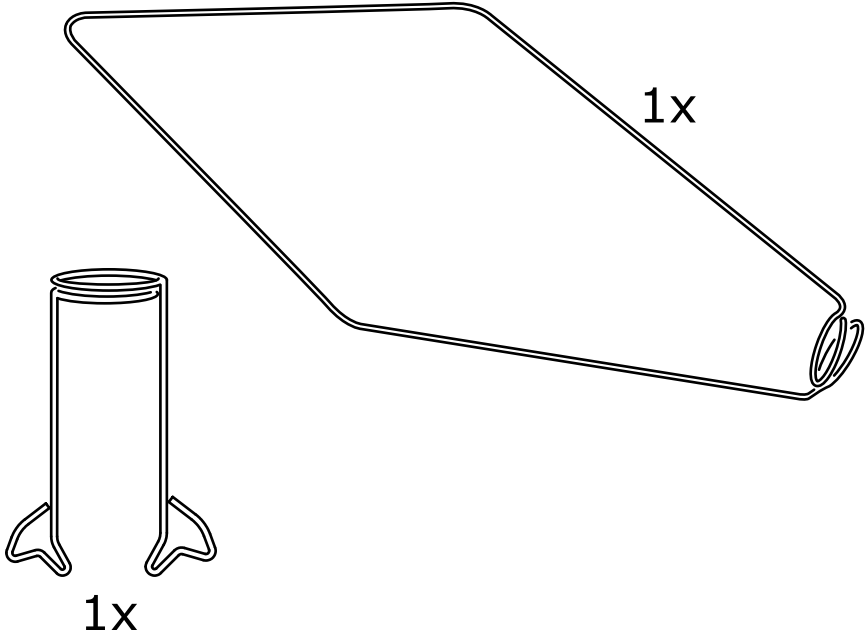
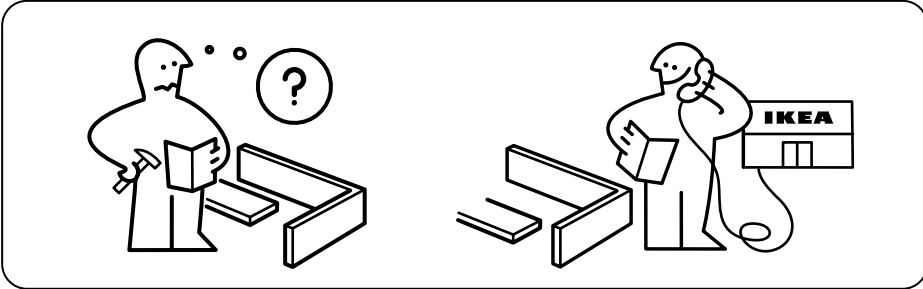

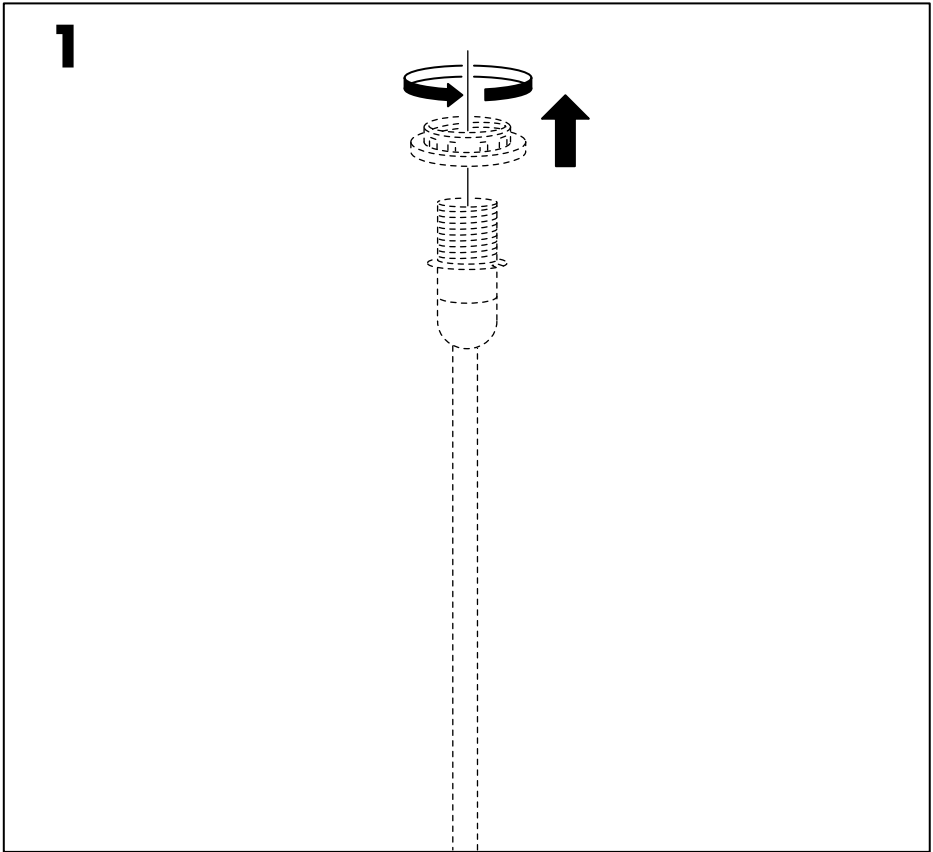
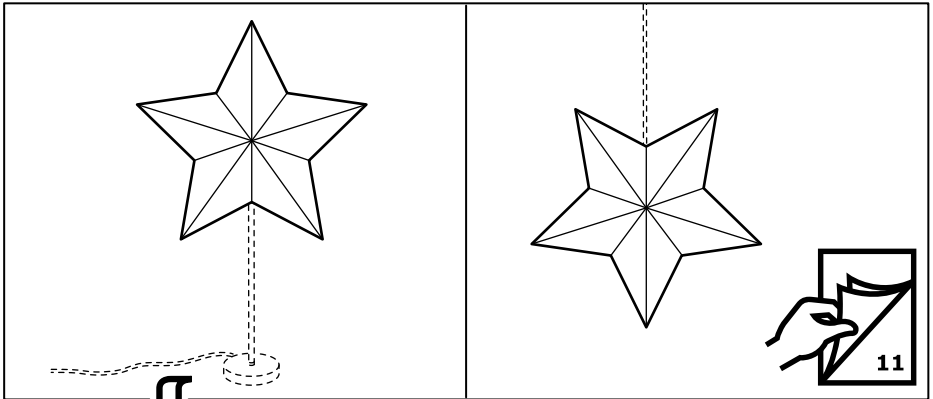

2

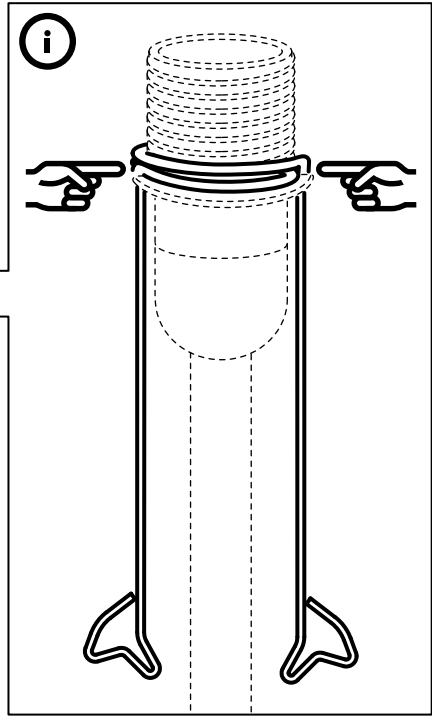
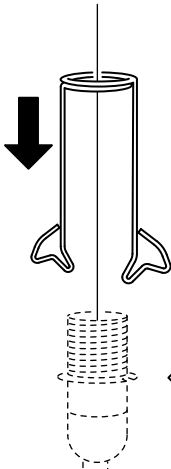

3

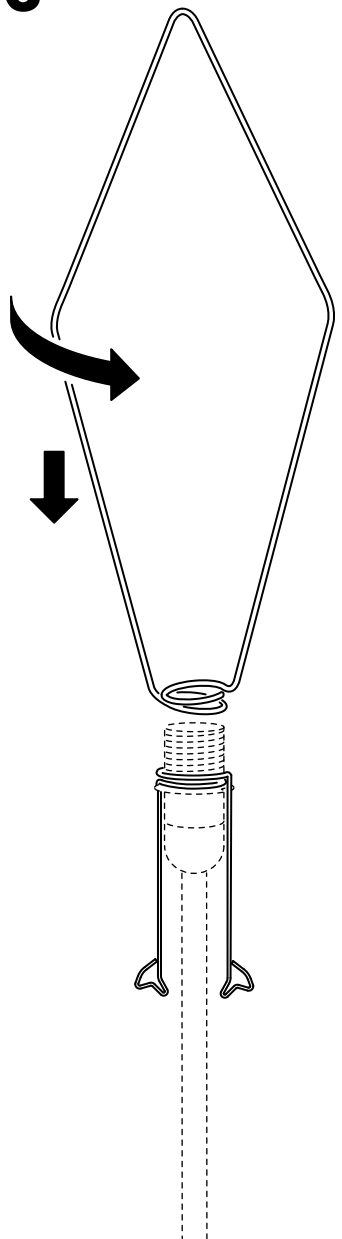

4

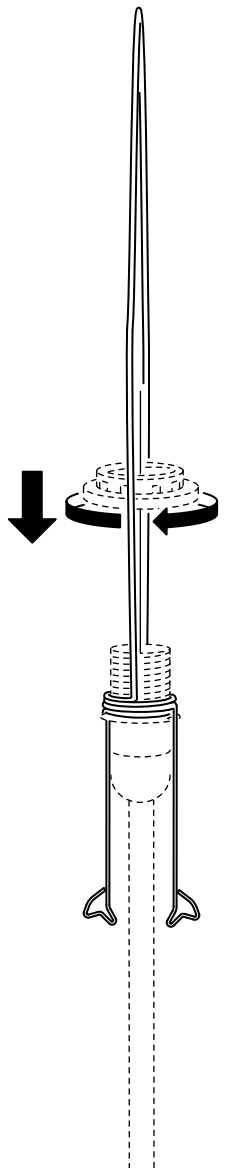

5

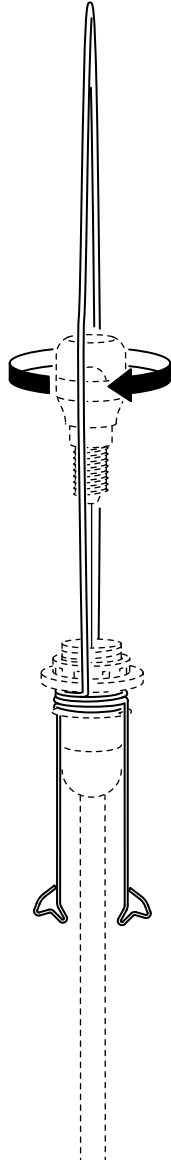

6

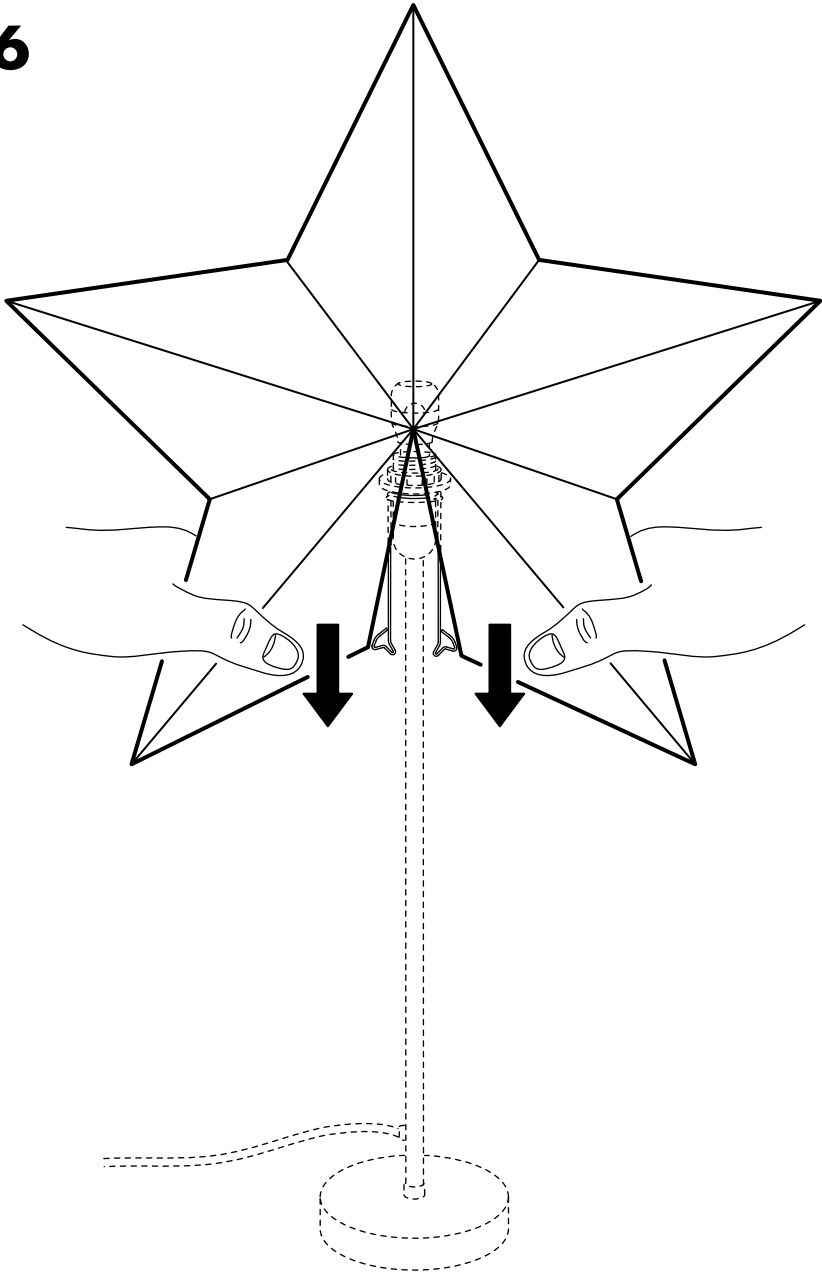

7

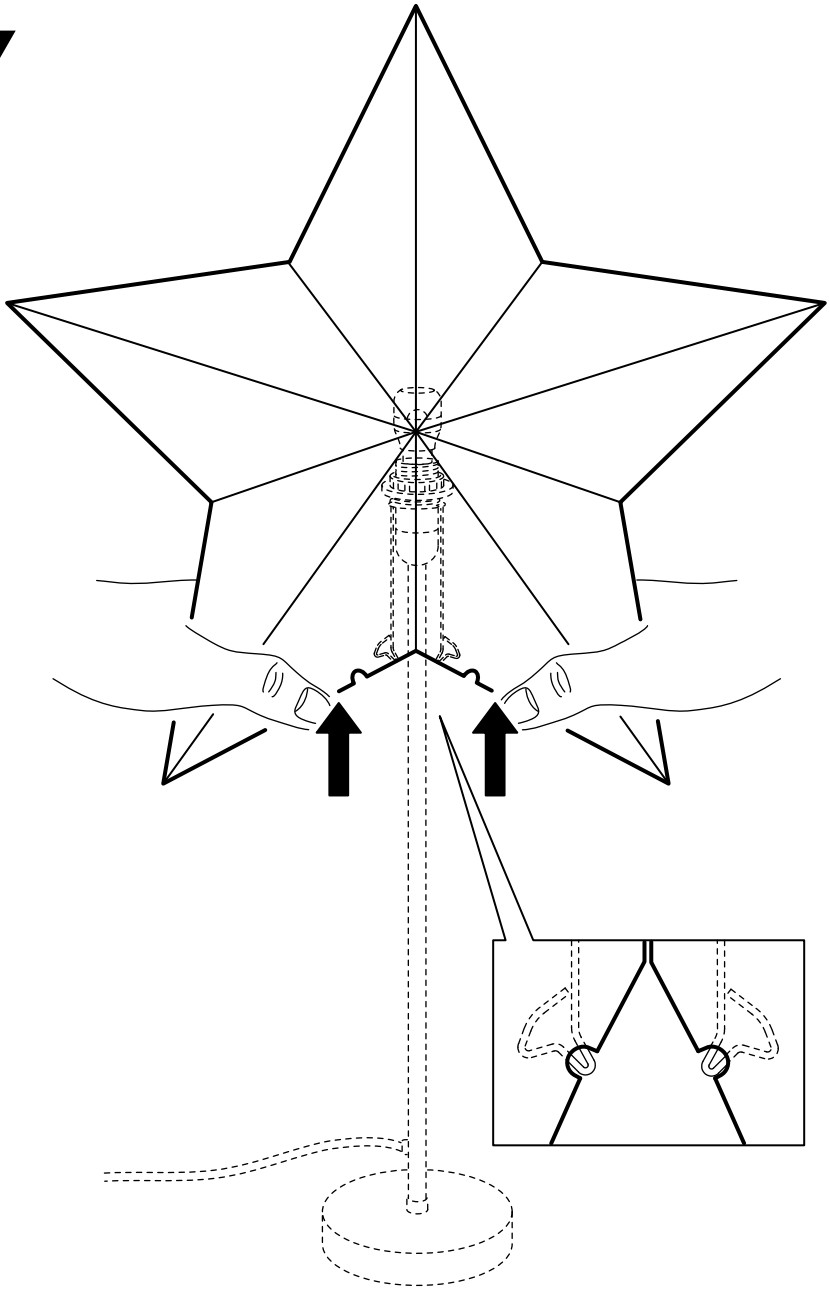

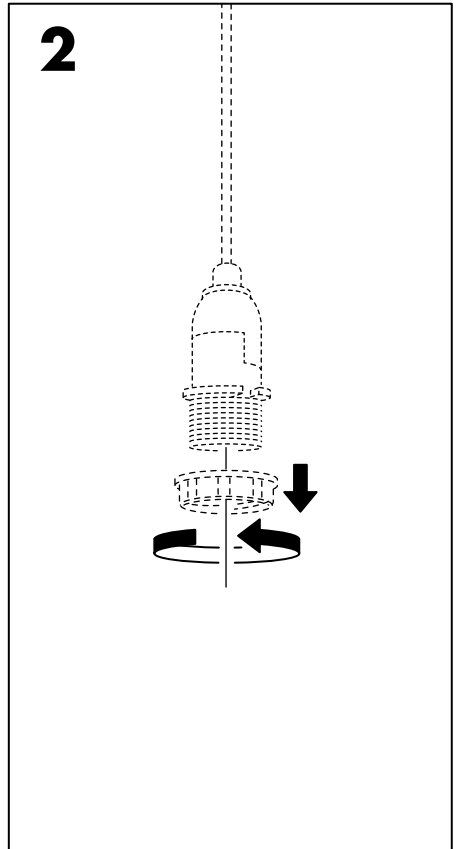
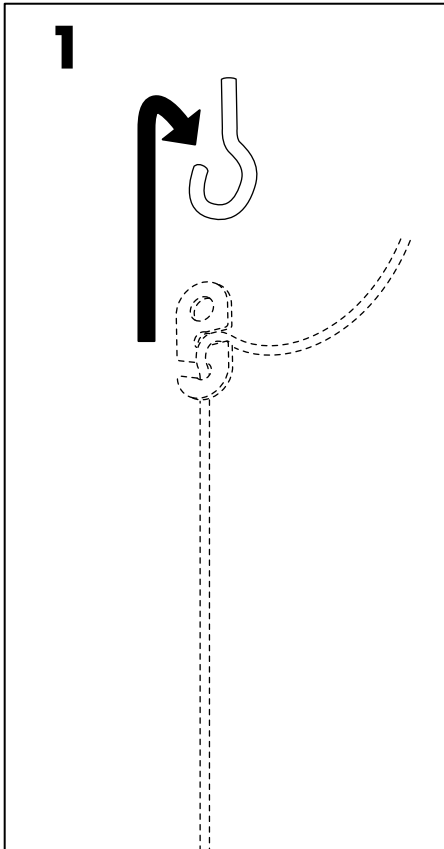
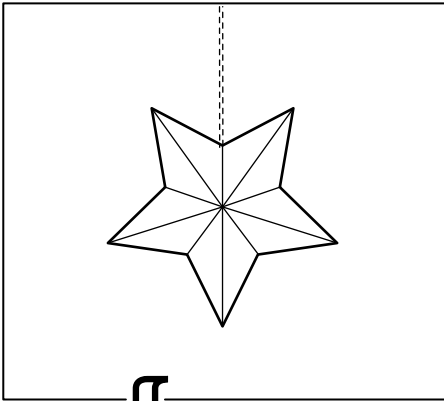

3

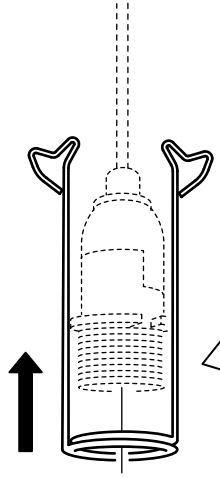

i

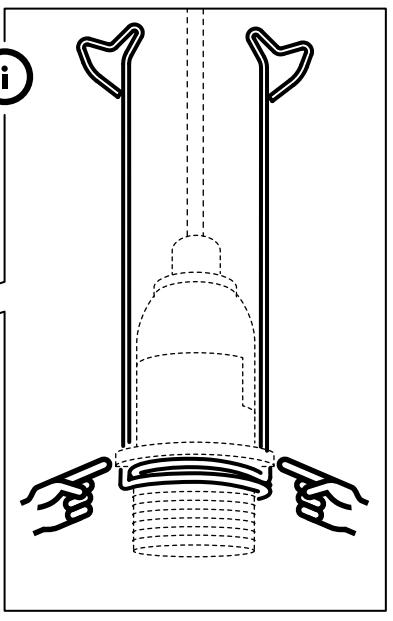

4

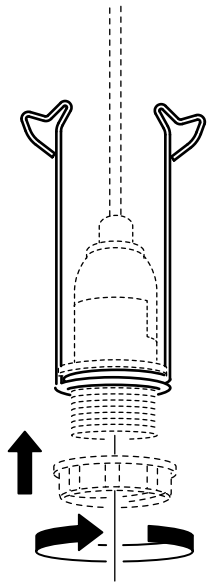

5

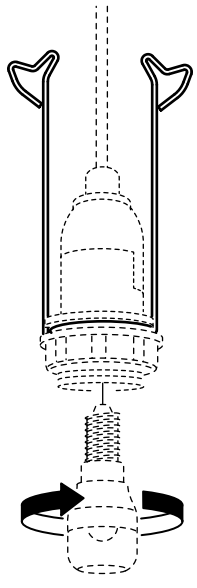

6

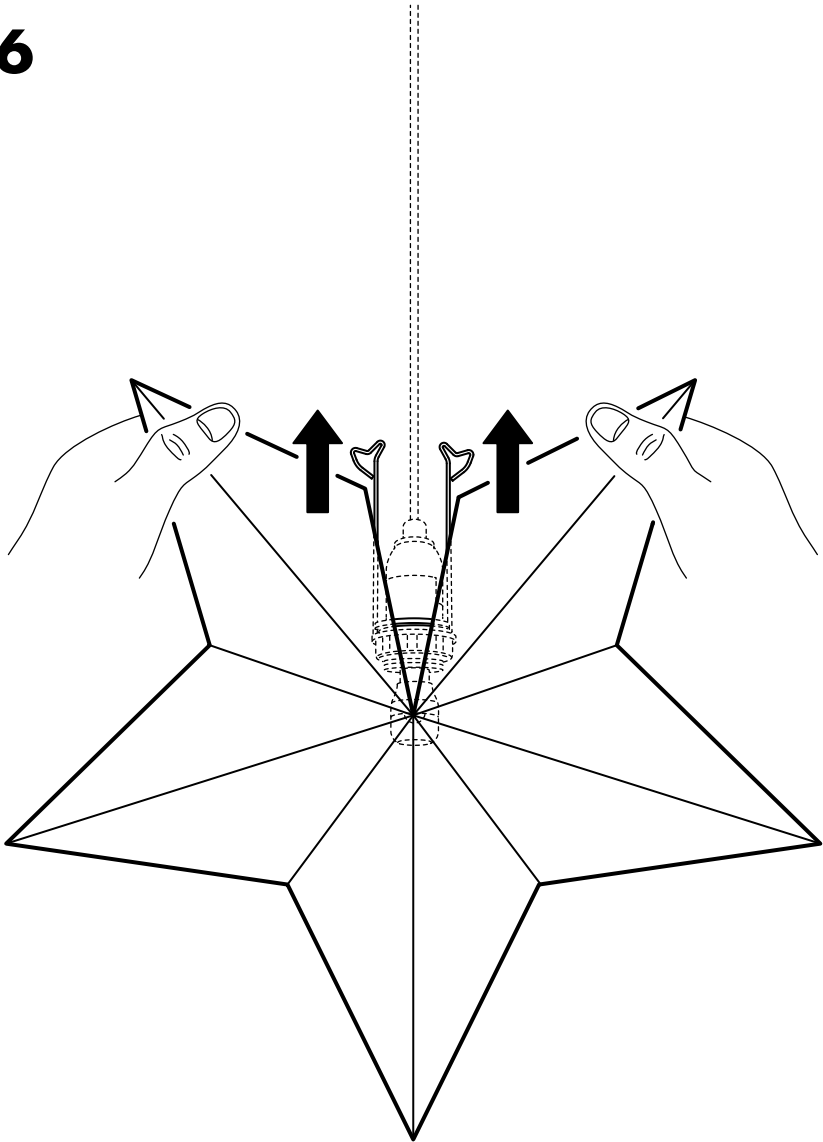

7

