

GB

STÄLLBAR

WM 6D

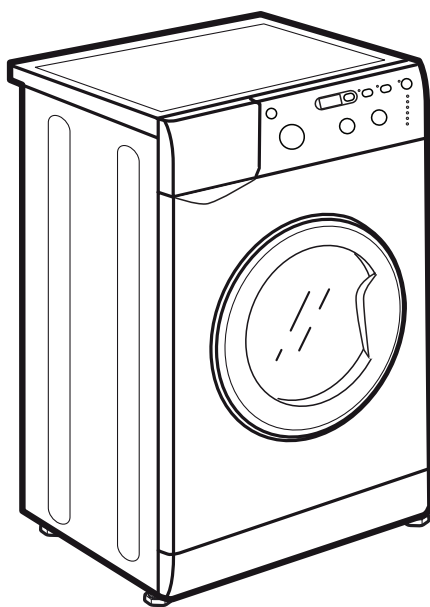

Design and Quality
IKEA of Sweden

English

4

Contents

Safety information	4	Tips and suggestions	14
Safety instructions	5	Care and maintenance	15
Product description	7	Troubleshooting	16
Control panel	9	Technical data	18
Preparation for initial use	10	Environmental concerns	19
Daily use	11	IKEA warranty	19
Wash cycles	12		

Safety information

Carefully read the instructions provided before installing and using the appliance. The machine is designed for household washing of textile products, sports shoes as well as for rinsing and squeezing. Synthetic detergents of low foaming shall be used. All processing operations are performed automatically according to program selected by user. The manufacturer shall not be held liable if defective installation and incorrect use of the appliance cause injuries and damages. Always store these instructions for future reference.

Safety of children and vulnerable persons

- This appliance may be used by children aged 8 years and above and by adults with limited physical, sensory or mental abilities, or who lack sufficient experience or knowledge regarding use of the appliance, only if they are supervised or have been trained to use the appliance and are aware of the attendant risks.
- Do not allow children to play with the appliance.
- Keep out of reach of children younger than 3 years unless they are constantly supervised.
- Keep packaging materials out of reach of children.
- Keep detergents out of reach of children.
- Keep children and pets out of reach of the appliance when it is open.

ENGLISH

- If the appliance comes with a child safety device, we recommend activating the latter.
- Cleaning and maintenance interventions must not be carried out by unsupervised children.

General safety warnings

- Do not modify the specifications of this appliance.
- Respect the 6 kg maximum load limit (consult the “Wash cycle table” paragraph).
- The water operating pressure (minimum and maximum) must be between 0.5 bar (0.05 MPa) and 10 bar (1 MPa).
- The vents along the base (where present) must not be obstructed by carpets.
- The appliance must be properly connected to the water network using the new hoses provided. Used hoses must not be re-used.
- If the power cord is damaged, it must be replaced by the manufacturer, an authorised technician or by a qualified person to prevent potential dangers.
- Before carrying out any maintenance activities, switch the appliance off and pull out the plug.
- Do not use nebulised water or steam to clean the appliance.
- Clean the appliance using a soft and damp cloth. Only use neutral detergents. Do not use abrasive products, abrasive sponges, solvents or metal objects.
- After use of the machine, you must disconnect it from the mains and switch off its water supply from the tap.

Safety instructions

Installation

- Remove all packaging materials and the transport bolts.
- Store the transport bolts. Before moving the appliance again, lock the drum.
- Always be careful when shifting the appliance as it is very heavy. Always wear protective gloves.
- Do not install or use the appliance if it is damaged.
- Observe the instructions supplied with the appliance.
- Do not install or use the appliance at temperatures below 0°C or in a position exposed to the elements.
- Make sure that the floor on which the appliance will be placed is level,

ENGLISH

- stable, resistant to heat and clean.
- Make sure that air can circulate freely between the appliance and the floor.
- Adjust the feet to arrange the necessary space between the appliance and wall-to-wall carpet.
- Do not install the appliance in a point where the door cannot be opened fully.

Electrical connections

- The appliance must have an earthing system.
- Always use a power socket with a properly installed protection contact.
- Check that the data on the appliance's data plate matches that of the electrical system. If not, contact an electrician.
- Do not use multiple sockets and extensions.
- Be careful not to damage the plug and power cord. If the power cord must be replaced, contact our IKEA appointed After Sales Service Provider and/or an authorized service partner for the necessary support.
- Insert the plug into the power socket only once the appliance has been installed. Verify that the plug remains accessible after installation.
- Do not touch the power cord or plug with wet hands.
- Do not pull on the power cord to disconnect the appliance. Always pull the plug instead.

Water supply connections

- Be careful not to damage the water loading and drain hoses.
- Before connecting the appliance to new hoses or hoses that have not been used for a long time, run the water until it becomes clear.

- When using the appliance for the first time, make sure that there are no water leaks.

Use



- BEWARE!** There is a risk of injury, electric shock, fire, burns or damage to the appliance.
- Use the appliance exclusively in a domestic environment.
- Observe the safety instructions appearing on the detergent's package.
- Do not place or keep flammable liquids or materials, nor easily flammable objects, on the appliance, inside the latter or in the immediate vicinity.
- Remove all metal objects from laundry.
- Do not place a container beneath the appliance to collect possible water leaks. Contact the IKEA appointed After Sales Service Provider and/or an authorized service partner for information on the suitable accessories to be used.
- Do not touch the glass of the door when a wash cycle is under way. The glass may be hot.

Technical assistance

- To repair the appliance contact the authorised IKEA appointed After Sales Service Provider and/or an authorized service partner.
- Only use original spare parts.

Disposal

⚠ BEWARE! Risk of injury or suffocation.

- Pull out the plug from the power socket.
- Cut the power cord and dispose of it.

Storage and transportation conditions

- A packaged washing machine should be stored at a relative humidity of no more than 80% in enclosed premises with natural ventilation. If the machine will not be used for a long period of time and will not be stored in heated premises, water must be completely removed from

the machine. Prior to transportation, transport screws with bushings must be fitted in the machine, to prevent damage to the washing machine drum. The machine must be transported in a vertical position (as it would stand for regular operation) using any form of covered vehicle, ensuring it is properly secured in place. **DO NOT** subject the washing machine to mechanical impact during loading and unloading. Standards for the sale of goods are not regulated by the manufacturer, but must comply with national, regional and international standards.

Product description

Overview of the appliance

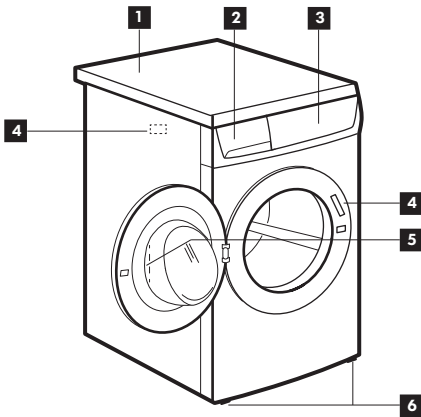

- 1 Worktop
- 2 Detergent container
- 3 Control panel
- 4 Data plate
- 5 Door handle
- 6 Feet for levelling the washing machine

ENGLISH

Detergent dispenser drawer

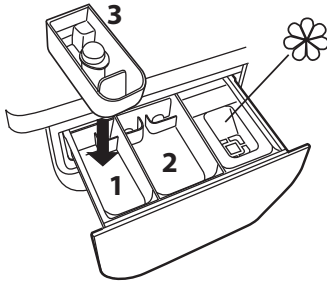

compartment 1: pre-washing detergent

(powder)

Before pouring in the detergent, make sure that extra compartment 3 has been removed.

compartment 2: detergent for the main wash

(powder or liquid)

Liquid detergent should only be poured in immediately prior to the start of the wash cycle.



compartment : additives (fabric softener, etc.)

The fabric softener should not overflow from the grid.

extra compartment 3: bleach

Bleaching

! **Traditional** bleach should be used on resistant white fabrics, and delicate bleach for coloured, synthetic and wool fabrics.

To run the bleach cycle on its own, pour the bleach into extra compartment 3, set the "Rinse"  cycle and activate the "Stain Removal"  function.

To bleach during a wash cycle, pour the detergent and additives then set the desired wash cycle and enable the "Stain Removal"  function.

The use of extra compartment 3 excludes the pre-wash function.

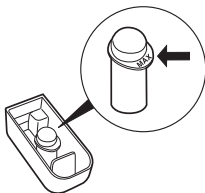

Insert extra compartment 3 (supplied) into compartment 1. When pouring in the bleach, be careful not to exceed the "max" level marked on the central pivot (see figure).

Control panel

Control panel description

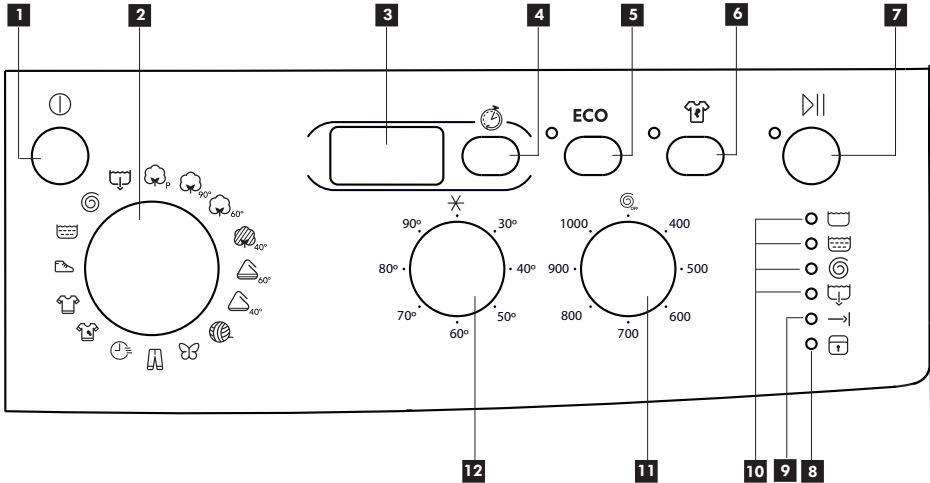

1 ON/OFF button

2 Wash cycle selector knob

3 Display

4 Delay Start button

5 Rapid button

6 Stain Removal button

7 Start/Pause button

8 Door locked indicator

9 Cycle end indicator

10 Wash cycle phase indicators







11 Spin speed selector knob

12 Temperature selector knob

Wash cycle phase indicators

- Wash
- Rinse
- Spin
- Drain

ⓘ ON/OFF button	Switches the washing machine on and off.
Wash cycle selector knob	Used to set the wash cycles. During the wash cycle, the knob does not move.
Display	Used to view the duration of the various cycles available and the remaining time of a running cycle; if the DELAY START option has been selected, the countdown to the start of the selected wash cycle will appear.
🕒 Delay Start button	Press to set a delayed start for the selected wash cycle; the delay period will appear on the display.

<p>ECO Rapid button</p>	<p>Selecting this option allows for optimally adjusting the drum rotation, temperature and water for a reduced load of lightly soiled cotton and synthetic garments. The ECO function allows for washing in less time, thereby saving water and electricity. We suggest using liquid detergent suitably measured out to the load quantity.</p>
<p> Stain Removal button</p>	<p>Bleaching cycle designed to remove the toughest stains. Remember to pour the bleach into extra compartment 3 (see "Bleaching").</p>
<p> Start/Pause button</p>	<p>To start or temporarily interrupt wash cycles. N.B.: press this button to pause a running wash cycle: the corresponding indicator light will flash orange, while the indicator light for the current wash cycle phase will remain steady lit. If the DOOR LOCKED  indicator light is switched off, the door may be opened. To start the wash cycle from the point at which it was interrupted, press this button again.</p>
<p> Door locked indicator</p>	<p>The lit indicator light indicates that the door is locked to prevent it from being opened; make sure that the indicator light is off before opening the door (wait approximately 3 minutes). To open the door while a wash cycle is in progress, press the START/PAUSE button; the door may be opened once the DOOR LOCKED indicator light turns off.</p>
<p>Wash cycle phase indicators</p>	<p>Once the desired wash cycle has been selected and has begun, the indicator lights switch on one-by-one to indicate which phase of the cycle is currently in progress.</p>
<p>Spin speed selector knob</p>	<p>Turn the SPIN SPEED knob to set the spin speed for the selected wash cycle. The spin speed can be lowered, or the spin cycle can be excluded altogether by selecting symbol . The washing machine will automatically prevent you from selecting a spin speed higher than the maximum speed set for each wash cycle.</p>
<p>Temperature selector knob</p>	<p>Turn the TEMPERATURE knob to set the wash temperature. The temperature can be lowered down to the cold wash setting . The washing machine will automatically prevent you from selecting a temperature higher than the maximum value for each wash cycle.</p>

Preparation for initial use

1. Make sure that the electrical and plumbing connections conform to the installation instructions.
2. Remove all materials from the drum.
3. Once the appliance has been installed, and before it is used for the first time, run a wash cycle with detergent and without laundry, using wash cycle .

Daily use

Preparing the laundry



- Divide the laundry according to:
 - the type of fabric / the symbol on the label
 - colours: separate coloured garments from whites.
- Empty all garment pockets and check the buttons.
- Do not exceed the values listed in the "Wash cycle table", which refer to the weight of dry laundry.

How much does your laundry weigh?

- 1 sheet 400–500 g
- 1 pillow case 150–200 g
- 1 tablecloth 400–500 g
- 1 bathrobe 900–1,200 g
- 1 towel 150–250 g

Starting a wash cycle

Open the water tap. Plug in the appliance.

1. Turn the washing machine on by pressing the  button. After switching on for a few seconds, all the indicator lights will switch off and the  indicator light will pulse.
2. Load the laundry and close the door.







WARNING!
Make sure that no laundry lies between the seal and the door.

This may cause water to leak or may damage the laundry.

3. Set the WASH CYCLE knob to the desired cycle.
4. Set the washing temperature.
5. Set the spin speed.
6. Pour the detergent and additives.
7. Select the desired options:
 - if the selected option is not com-

patible with the set wash cycle, the indicator light will flash and the option will not be activated;

- if the selected option is not compatible with another previously selected option, the indicator light corresponding to the first option selected will flash and only the second option will be activated; the indicator light corresponding to the active option will light up.

8. Start the wash cycle by pressing the  button; the corresponding indicator light will remain lit steady green. To cancel the set wash cycle, pause the machine by pressing the  button and select a new cycle.
9. At the end of the wash cycle the  indicator light will light up. The door can be opened once the DOOR LOCKED  indicator light switches off. Take out the laundry and leave the appliance door ajar to let the drum dry. Turn the washing machine off by pressing the  button.

















Stand-by mode

In accordance with the latest energy saving regulations, this washing machine is fitted with an automatic switch-off (stand-by) system that intervenes after roughly 30 minutes if no activity is detected. Press the  button briefly and wait for the machine to start up again. Consumption in off-mode: 0.5 W
Consumption in Left-on mode: 8 W
This power value was measured according to EN 60456.

Wash cycles

Wash cycle table



 Always refer to the symbol on the garment label and select the corresponding wash cycle.

Wash cycles	Wash cycle description	Max temp. (°C)	Max speed (rpm)	Detergents				Max load (kg)	Cycle duration
				Pre-wash	Wash	Bleaching	Fabric softener		
	Cottons with pre-wash: heavily soiled whites.	90°	1,000	■	■	-	■	6	The duration of the wash cycles can be monitored on the display.
	Cotton whites: heavily soiled whites.	90°	1,000	-	■	■	■	6	
	White cottons (1): heavily soiled whites and resistant colours.	60°	1,000	-	■	■	■	6	
	Cottons: heavily soiled whites and resistant colours.	60°	1,000	-	■	■	■	6	
	Coloured cottons: lightly soiled whites and delicate colours.	40°	1,000	-	■	■	■	6	
	Intensive synthetics: heavily soiled resistant colours.	60°	1,000	-	■	■	■	2.5	
	Delicate synthetics: lightly soiled delicate colours.	40°	1,000	-	■	■	■	2.5	
	Wool: for wool, cashmere, etc.	40°	800	-	■	-	■	1	
	Silk and curtains: for garments made of silk and viscose, lingerie	30°	0	-	■	-	■	1	
	Jeans	40°	800	-	■	-	■	2.5	
	Express: to rapidly refresh lightly soiled garments (not suitable for wool, silk and clothes that require hand-washing).	30°	800	-	■	-	■	1.5	
	Sport Intensive	30°	600	-	■	-	■	2.5	
	Sport Light	30°	600	-	■	-	■	2.5	
	Special Shoes	30°	600	-	■	-	■	Max 2 pairs	
	Rinse	-	1,000	-	-	■	■	6	
	Spin	-	1,000	-	-	-	-	6	
	Drain	-	0	-	-	-	-	6	

The cycle duration indicated on the display or instruction manual is an estimate based on standard conditions. The actual duration may vary in relation to several factors, such as the temperature and pressure of the incoming water, ambient temperature, amount of detergent, load quantity and type, load balancing and any additional options selected.

1) Test cycle in accordance with the EN 60456 standard: set the  wash cycle with a temperature of 60°C.

Special wash cycles

Express ( wash cycle) is designed for rapidly washing lightly soiled garments: it lasts a mere 15 minutes, thereby saving electricity and time. Selecting this was cycle ( at 30°C) allows for washing different fabrics together (except for wool and silk) with a 1 kg maximum load.

Sport Intensive ( cycle) is studied for washing heavily soiled sports clothing fabrics (tracksuits, shorts, etc.); for best results, we recommend not exceeding the maximum load indicated in the "Wash cycle table".

Sport Light ( cycle) is studied for washing lightly soiled sports clothing fabrics (tracksuits, shorts, etc.); for best

ENGLISH

results, we recommend not exceeding the maximum load indicated in the "Wash cycle table". We recommend using liquid detergent and adding the amount suitable for a half-load.

Sport Shoes (👟 cycle) is studied for washing sports shoes; for best results, do not wash more than 2 pairs simultaneously.

Wool: the 🧶 wash cycle can be used to wash all woollen garments in the machine, even those carrying the "hand wash only" label 🧺. For best results, use a special detergent and do not exceed the maximum load of 1 kg.

Silk: use the appropriate 🦋 wash cycle to wash all silk garments. We recommend using a special detergent formulated for washing delicate garments.

Curtains: we recommend folding the curtains and placing them in a pillow case or mesh bag. Use the 🦋 wash cycle.

Jeans: reverse garments before washing and use liquid detergent. Use the 👖 wash cycle.

Washing options / wash cycle compatibility

Wash cycle	🕒	ECO	👕
👟	■	-	-
👟	■	-	■
👟	■	■	■
🧶	■	■	■
🧺	■	■	■
🧺	■	■	■
🦋	■	-	-
🦋	■	-	-
👖	■	-	-
🕒	■	-	-
👕	■	-	-
👕	■	-	-
👟	■	-	-
🧺	■	-	■
🧺	■	-	-
👕	■	-	-

Tips and suggestions

The laundry load

- Divide the laundry into: whites, coloureds, synthetics, delicates and wool.
- Refer to the washing instructions indicated on the garment washing labels.
- Do not wash white and coloured garments together.
- Certain coloured garments can fade when washed for the first time. We recommend washing them separately the first few times.
- Button up pillow cases and close zips, hooks and buttons. Close belts.
- Turn multi-layer fabrics, woollen clothes and garments with printed images inside-out.
- Remove stubborn stains.
- Wash stubborn stains with special detergent.
- Be careful with curtains. Remove all hooks or place the curtains in a pillow case or mesh bag.
- Do not wash hemless or torn garments inside the appliance. Use a mesh bag to wash small items and/or delicate garments (e.g. bras with underwire, belts, stockings, etc.).
- A very small load may cause balancing problems during the spin cycle. If this happens, manually arrange the garments in the drum and restart the spin cycle.

Stubborn stains

For certain stains, water and detergent are not sufficient.

We recommend removing these stains before putting the garments into the washing machine.

Special stain removers can be purchased. Use a special stain remover suited to the type of stain and fabric.

Detergents and additives

- Exclusively use detergents and additives suitable for washing machine washes:
 - powder detergents suitable for all types of fabrics;
 - powder detergents suitable for delicate fabrics (max 40°C) and wool;
 - liquid detergents, preferably for low-temperature wash cycles (max 60°C), suitable for all types of fabrics or specially formulated for wool.
- Avoid mixing different types of detergents.
- For ecological reasons, avoid using more detergent than necessary.
- Observe the instructions appearing on the relevant product packages.
- Use products suited to the type and colour of the fabric, the wash cycle temperature and level of dirt.

Ecological tips

- Set a wash cycle without the pre-wash phase to wash normally soiled laundry.
- Start a wash cycle with the maximum laundry load.
- If necessary, use a stain remover when setting a low-temperature wash cycle.
- To use the right amount of detergent, verify the hardness of the water of the domestic water supply system.

Water hardness

If the local water is very or moderately hard, we recommend using a water softener for washing machine use. A water softener is not necessary for areas where the water is soft.

For information on the hardness of the local water, contact the local water supply company.

Use the right amount of water softener. Observe the instructions appearing on the product packages.

Care and maintenance

Cutting off the water and electricity supplies

- Close the water tap after every wash cycle. This will limit wear on the hydraulic system inside the washing machine and help to prevent leaks.
- Unplug the washing machine when cleaning it and during all maintenance work.

Cleaning the washing machine

The outer parts and rubber components of the appliance can be cleaned using a soft cloth soaked in lukewarm soapy water. Do not use solvents or abrasives.

Cleaning the detergent dispenser drawer

Remove the detergent dispenser drawer by pulling it outwards (see figure). Wash it under running water; this procedure should be effected regularly.

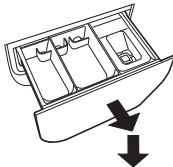

Caring for the door and drum

Always leave the porthole door ajar in order to prevent unpleasant odours from forming.

Cleaning the pump

The washing machine is fitted with a self-cleaning pump that does not require any maintenance. Small items (such as coins or buttons) may sometimes fall into the protective pre-chamber situated at the base of the pump.

! Make sure that the wash cycle has ended and unplug the appliance.

To access the pre-chamber:

1. using a screwdriver, remove the cover panel on the lower front part of the washing machine (see figure);

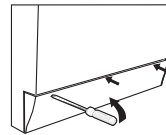

2. loosen the cover by turning it anti-clockwise (see figure): it is normal for some water to leak out;

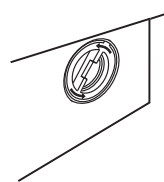

3. clean the inside thoroughly;
4. screw the cover back on;
5. put the panel back in place, making sure that the hooks slot into place before pushing the panel onto the appliance.

Inspecting the water inlet hose

Inspect the inlet hose at least once a year. If it is cracked or broken, it must be replaced: during wash cycles, the high pressure of the water could suddenly split the hose open.

! Never use hoses that have already been used.

Troubleshooting

The washing machine may occasionally fail to work. Before contacting the Technical Assistance Service, make sure that the problem cannot be easily solved using the following list.

Anomalies	Possible causes / Solution:
The washing machine does not start.	<ul style="list-style-type: none"> • The appliance is not plugged into the socket, or not sufficiently to make contact. • There is no power in the house.
The wash cycle does not start.	<ul style="list-style-type: none"> • The washing machine door is not closed properly. • The ON/OFF button has not been pressed. • The START/PAUSE button has not been pressed. • The water tap has not been opened. • A delay has been set for the start time.
The washing machine - the display).	<ul style="list-style-type: none"> • The water inlet hose is not connected to the tap. • The hose is bent. • The water tap has not been opened. • There is no water supply in the house. • The pressure is too low. • The START/PAUSE button has not been pressed.
The washing machine continuously loads and unloads water.	<ul style="list-style-type: none"> • The drain hose is not fitted between 65 cm and 100 cm from the floor. • The free end of the hose is immersed in water. • The wall drainage system does not have a breather pipe. • If the problem persists even after these checks, close the water tap, switch the appliance off and contact the IKEA appointed After Sales Service Provider and/or an authorized service partner. If the home is on one of the upper floors of a building, there may be problems relating to back-siphonage, causing the washing machine to fill with water and drain continuously. Special anti-siphon valves are available in shops and help to prevent this inconvenience.
The washing machine does not drain nor spin.	<ul style="list-style-type: none"> • The cycle does not include drainage: with certain cycles it must be started manually. • The drain hose is bent. • The drainage duct is clogged.
The washing machine vibrates a lot during the spin cycle.	<ul style="list-style-type: none"> • The drum was not unlocked correctly during installation. • The washing machine is not level. • The washing machine is tucked between furniture cabinets and the wall.

ENGLISH

The washing machine leaks.	<ul style="list-style-type: none">• The water inlet hose is not screwed on properly.• The detergent dispenser drawer is obstructed.• The drain hose is not properly attached.
The "option" indicator lights and the Start/Pause indicator light "phase in progress" indicator lights and the "door locked" indicator light remain steady lit.	<ul style="list-style-type: none">• Switch off the machine and unplug it, wait for approximately 1 minute then switch it back on again. If the problem persists, contact the IKEA appointed After Sales Service Provider and/or an authorized service partner.
There is too much foam.	<ul style="list-style-type: none">• The detergent is not suitable for machine washing (it should be marked with "for washing machine use" or "hand wash and machine wash" or similar).• Too much detergent was used.

Before contacting the IKEA appointed After Sales Service Provider and/or an authorized service partner:





- Check whether you can solve the problem on your own, according to the recommendations of this troubleshooting guide,
- Restart the wash cycle to check whether the problem has been solved.
- If not, contact the IKEA appointed After Sales Service Provider and/or an authorized service partner.

Have the following information on hand:

- The type of problem.
- The appliance model (Mod.).
- The serial number (S/N).

This information can be found on the data plate applied to the rear of the washing machine, and can also be found on the front of the appliance by opening the door.

Technical data

Model	Washing machine STÄLLBAR WM 6D
Manufacturer country	Russia
Manufacturer	"INDESIT INTERNATIONAL" for IKEA Address: Russia, Lipetsk, pl. Metallurgic, 2
Dimensions	width 59.5 cm height 84,5 cm depth 44 cm
Capacity	between 1 and 6 kg
Rated voltage or voltage range	220-240 V
Maximum power	1850 W
Conventional designation of the type of electric current or nominal frequency of alternating current	50 Hz
Protection class against electric shock	Protection class I
Water connections	maximum pressure 1 MPa (10 bar) minimum pressure 0.05 MPa (0.5 bar) drum capacity 40 litres
Spin speed	up to 1,000 rpm
Test wash cycles in compliance with the EN 60456 standard	Wash cycle  : temperature 60°C.
  	<p>This appliance conforms to the following European directives:</p> <ul style="list-style-type: none"> - EMC - 2014/30/EU (Electromagnetic Com-patibility) - 2012/19/EU (WEEE) - LVD - 2014/35/EU (Low Voltage Directive) TC 004/2011, TC 020/2011 and local regulatory documents
The date of production, ordinal number and code of model of this technique can be obtained from the serial number located above the bar-code (I.C. XXXXXXXXXXXXX S/NXXXXXXXXXXXX), as follows	<ul style="list-style-type: none"> - The 1st and 12th digit in I.C. corresponds to the code of the model, - The 1st and 2rd digit in S / N corresponds to the plant code, - 3nd and 4th digits in S / N - the year of production, - 5th and 6th digits in S / N - week of production, - 7th and 12th digit in S/N - progressive number.
Degree of protection against solid particles and moisture, provided by a protective sheath, with the exception of low-voltage equipment that does not have protection from moisture: IPX4	
Energy efficiency class	A

The manufacturer sets the product for a service life of 10 (ten) years from the date of transfer of the product to the first buyer. The procedure for calculating this period is made in accordance with the Law of the Russian Federation "On Protection of Consumer Rights". In the absence of a document confirming the fact of sale, this period begins to be calculated from the date of manufacture of the product. After life cycle has been finished, or in case you decided to stop using product earlier, please address to appropriate officials to legally destroy the appliance.

Environmental concerns

Recycle parts that have the  symbol. Put the packaging in recycling containers. By recycling an old home electrical appliance you are helping to protect the environment and people's health.

Do not dispose of a home electrical appliance with the  symbol with ordinary household waste.

Take the appliance to the local recycling centre or contact your local authority.

For IKEA product quality issues, contact the seller: LLC "IKEA DOM" 141400, Moscow region, Khimki, IKEA microdistrict, Corp. 1 - via the form at <http://www.IKEA.ru/>, on phone 8 (800) 234-55-66 or to the IKEA Service department at any IKEA store

IKEA warranty

IKEA guarantee validity period

The guarantee for this appliance is valid for a period of two (2) years. This guarantee is valid from the date of purchase. Please retain the receipt as proof of purchase and date of purchase.

Any repair carried out within the guarantee period, will not extend the guarantee for the appliance or the new parts.

Who will execute the service?

IKEA appointed After Sales Service Provider and/or an authorized service partner will provide the service through its own service operations. At the end of the warranty period, you are advised to check the quality of your product at the authorized service centers at least once in every three years.

What is covered under this guarantee?

This guarantee covers faults in the appliance, which have been caused by faulty construction or material faults

from the date of purchase from an IKEA store. This guarantee applies to domestic use of the appliance only. All the exceptions are specified under the heading "What is not covered under this guarantee?". The guarantee provides for reimbursement of the costs of remedying the fault, e.g. repair costs, spare parts, labour, and travel expenses – provided that the appliance is accessible for repair without difficulty or special expenditure, and that the fault is caused by faulty construction or material faults covered under the guarantee. Replaced parts become the property of IKEA.

What will IKEA do to correct the problem?

An IKEA appointed After Sales Service Provider or an authorized service partner will examine the product and decide if it is covered under this guarantee. If considered covered by the guarantee, the IKEA appointed After Sales Service Provider or authorized service partner, will then, at its sole discretion, repair the defective appliance or replace it with the same or a comparable product.

What is not covered under this guarantee?

- Normal wear and tear.
- Deliberate or negligent damage, damage caused by failure to observe operating instructions, incorrect installation or by connection to the wrong voltage. Damage caused by chemical or electro-chemical reaction, poor water quality (for example extremely hard water), exposure to atmospheric factors or abnormal environmental conditions.
- Consumable parts, for example batteries and light bulbs.
- Damage to decorative and non-functional parts, which do not affect normal use of the appliance, including any scratches and possible colour differences.
- Damage to the following parts: Feed and drainage pipes, seals, lamps and lamp covers, screens, handles, coverings and parts of coverings and casings - unless such damage can be proved to be due to production faults.
- Cases where no fault could be found during a technician's visit.
- Repairs carried out by companies who are not IKEA appointed After Sales Service Provider or an authorised service partner or when non-original parts have been used for a repair.
- Repair that was due to incorrect installation and which does not meet the specified requirements.
- Use of an appliance for non-domestic means, i.e. commercial or professional use.
- Transportation damage. If a customer transports the appliance themselves to their home or other address, IKEA is not liable for any damage that may occur during transport.

However, in the case of IKEA delivery of the appliance, any damage to the product that occurs during this delivery will be covered under this guarantee.

- The cost for carrying out the initial installation of the IKEA appliance. If the IKEA appointed After Sales Service Provider or authorized service partner repairs or replaces the appliance under the terms of this guarantee, they must also re-install the repaired appliance or install the replacement, if necessary.

These restrictions do not apply if the installation was carried out by a qualified specialist using original parts in order to adapt the home appliance to technical safety specifications.

Legal rights by country

The guarantee provided by IKEA fully covers or even exceeds all requirements of local law, which may vary from country to country.

IKEA appointed After Sales Service Provider and an authorized service partner

You can contact the IKEA appointed After Sales Service Provider or an authorized service partner for the following:

1. Repairs under guarantee;
2. Recommendations and technical advice on installing appliances purchased in an IKEA store; The service centre cannot give advice on the following matters:
 - questions about installing IKEA kitchen furniture;
 - connection to the mains if the appliance does not have a fitted plug and cable; connection to the water supply. This type of work should be carried out by an authorised professional.

ENGLISH

3. For an explanation of how to use an appliance purchased at an IKEA store, or how it works.

To ensure maximum performance, please carefully read the documentation and instructions for use that accompany your new appliance before contacting the service centre.

How to reach us if you need our help



Please refer to the list of authorised IKEA service centres, which is provided on the last page of these instructions.

- i** To ensure we can deal with your service in a timely manner, please quote 20-digit serial number and 8-digit article number when contacting the service centre.
- i** **SAVE THE SALES RECEIPT!**
The receipt is your proof of purchase and is required for the guarantee to apply.

Do you need some more help?

For any additional questions, not related to the guarantee, please contact IKEA Customer Service at your nearest IKEA store. Please read the accompanying documentation carefully before contacting us.

BELGIË - BELGIQUE - BELGIEN

Telefoon/Numéro de téléphone/Telefon-Nummer:	026200311
Tarif/Tarif/Tarif:	Lokaal tarief/Prix d'un appel local/Ortstarif
Openingsstijd:	Maandag - Vrijdag 8.00 - 20.00
Heures d'ouverture:	Lundi - Vendredi 8.00 - 20.00
Öffnungszeiten:	Montag - Freitag 8.00 - 20.00

БЪЛГАРИЯ

Телефонен номер:	02 4003536
Тарифа:	Локална тарифа
Работно време:	понеделник - петък 8.00 - 20.00

ČESKÁ REPUBLIKA

Telefonní číslo:	225376400
Sazba:	Místní sazba
Pracovní doba:	Pondělí - Pátek 8.00 - 20.00

DANMARK

Telefonnummer:	70150909
Takst:	Lokal takst
Åbningstid:	Mandag - fredag 9.00 - 20.00 Lørdag (Åbent udvalgte søndage, se IKEA.dk) 9.00 - 18.00

DEUTSCHLAND

Telefon-Nummer:	06929993602
Tarif:	Ortstarif
Öffnungszeiten:	Montag - Freitag 8.00 - 20.00

ΕΛΛΑΔΑ

Τηλεφωνικός αριθμός:	2109696497
Χρέωση:	Τοπική χρέωση
Ώρες λειτουργίας:	Δευτέρα - Παρασκευή 8.00 - 20.00

ESPAÑA

Teléfono:	913754126 (España Continental)
Tarifa:	Tarifa local
Horario:	Lunes - Viernes 8.00 - 20.00

EESTI

<http://www.ikea.com>

FRANCE

Numéro de téléphone:	0170480513
Tarif:	Prix d'un appel local
Heures d'ouverture:	Lundi - Vendredi 9.00 - 21.00

HRVATSKA

Broj telefona:	0800 3636
Tarifa:	Lokalna tarifa
Radno vrijeme:	Ponedjeljak - Petak 8.00 - 20.00

ÍSLAND

Símanúmer:	5852409
Kostnaður við símtal:	Almennt mínútuverð
Opnunartími:	Mánudaga - Föstudaga 9.00 - 17.00

ITALIA

Telefono:	0238591334
Tariffa:	Tariffa locale
Orari d'apertura:	Lunedì - Venerdì 8.00 - 20.00

LATVIJA

<http://www.ikea.com>

LIETUVIŲ

Telefono numeris:	(0) 520 511 35
Skambučio kaina:	Vietos mokestis
Darbo laikas:	Nuo pirmadienio iki penktadienio 8.00 - 20.00

LUXEMBOURG

Numéro de téléphone:	035220882569
Tarif:	Prix d'un appel local
Heures d'ouverture:	Lundi - Vendredi 8.00 - 18.00

MAGYARORSZÁG

Telefon szám:	(06-1)-3285308
Tarifa:	Helyi tarifa
Nyitvatartási idő:	Hétfőtől Péntekig 8.00 - 20.00

NORGE

Telefon nummer:	23500112
Takst:	Lokal takst
Åpningstider:	Mandag - fredag 8.00 - 20.00



NEDERLAND

Telefoon:	0900-235 45 32 en/of 0900 BEL IKEA 0031-50 316 8772 international
Tarif:	Geen extra kosten. Alleen lokaal tarief.
Openingstijd:	Maandag t/m - Vrijdag 8.00 - 21.00 Zaterdag 9.00 - 21.00 Zondag / Feestdagen 10.00 - 18.00

ÖSTERREICH

Telefon-Nummer:	013602771461
Tarif:	Ortstarif
Öffnungszeiten:	Montag - Freitag 8.00 - 20.00

POLSKA

Numer telefonu:	225844203
Stawka:	Koszt połączenia według taryfy operatora
Godziny otwarcia:	Poniedziałek - Piątek 8.00-20.00

PORTUGAL

Telefone:	213164011
Tarifa:	Tarifa local
Horário:	Segunda - Sexta 9.00 - 21.00

ROMÂNIA

Număr de telefon:	021 2044888
Tarif:	Tarif local
Orar:	Luni - Vineri 8.00 - 20.00

РОССИЯ

Телефонный номер:	84957059426
Стоимость звонка:	Местная стоимость звонка
Время работы:	Понедельник - Пятница 9.00 - 21.00 (Московское время)

SCHWEIZ - SUISSE - SVIZZERA

Telefon-Nummer/Numéro de téléphone/Telefono:	0225675345
Tarif/Tarif/Tariffa:	Ortstarif/Prix d'un appel local/Tariffa locale
Öffnungszeiten:	Montag - Freitag 8.00 - 20.00
Heures d'ouverture:	Lundi - Vendredi 8.00 - 20.00
Orario d'apertura:	Lunedì - Venerdì 8.00 - 20.00

SLOVENSKO

Telefónne číslo:	(02) 50102658
Cena za hovor:	Cena za miestny hovor
Pracovná doba:	Pondelok až piatok 8.00 - 20.00

SLOVENIJA

<http://www.ikea.com>

SRBIJA

Број телефона:	011 7 555 444
стопа:	lokalna курс
Радно време:	Понедељак - субота 9.00 - 20.00 недеља 9.00 - 18.00

SUOMI

Puhelinnumero:	0981710374
Hinta:	Yksikköhinta
Aukioloaika:	Maanantaista perjantaihin 8.00 - 20.00

SVERIGE

Telefon nummer:	0775-700 500
Taxa:	Lokal samtal
Öppet tider:	Måndag - Fredag 8.30 - 20.00 Lördag - Söndag 9.30 - 18.00

UNITED KINGDOM - IRELAND

Phone number:	02076601517
Rate:	Local rate
Opening hours:	Monday - Friday 8.00am - 6.00pm Saturday 8.30am - 4.30pm Sunday 9.30am - 3.30pm

